

weldtech

ATP160

**160A INVERTER PLASMA CUTTER
/MMA(STICK)/TIG WELDER**

WORKSHOP RANGE



OPERATING INSTRUCTIONS

www.weldtech.net.nz



We Appreciate Your Business!

Congratulations on your new Weldtech product!

The Weldtech range from Euroquip uses latest technology design and engineering to produce welding products that combine market leading value and features with durability. Designed for discerning operators who seek professional results and product quality without the price tag of a full professional setup. Design emphasis is placed on simple, functional design and operation. Weldtech product is subject to stringent quality control and designed and manufactured to NZ & Australian standards.

Common use of Weldtech products include:

- Light Engineering
- Automotive
- Home/hobby Engineering
- Farming
- Maintenance & Repairs

For industrial welding solutions, check out the Strata range from Euroquip:

www.strata.co.nz

Euroquip is a market leading provider of innovative power equipment solutions to a wide range of industries across New Zealand and Australia. Key product categories are; welding equipment, air compressors, power generators and cleaning equipment.

Euroquip's slogan is 'empowering industries', find out more about the advantage Euroquip brings at **www.euroquip.co.nz**.

Contents

General Overview.....	5
Specifications.....	7
Box contents.....	8
Know your machine.....	9
Plasma Cutting.....	10
Quick Setup Guide.....	11
PT-31 Plasma Torch.....	12
Plasma Cutting Guide.....	13
TIG welding.....	15
Expanded View of TIG Torch.....	16
TIG Basic Welding Guide.....	17
TIG Welding Troubleshooting.....	19
MMA (Stick) Welding.....	20
MMA (Stick) Basic Welding Guide.....	21
MMA (Stick) Troubleshooting.....	27
Care & Maintenance.....	28
Accessories & Consumables.....	28
Knowledge & Resources.....	28
Change filter operation.....	29
Explosion Diagrams & Part List.....	30
Part List.....	31
Safety Warning.....	32
Warranty.....	35

ATP160

160A - INVERTER ARC-TIG -PLASMA CUTTER

The new Weldtech ATP160 Multi-process 3n1 ARC-TIG -PLASMA Cutting machine utilises the latest digital control technology to output an amazing 30 amps Plasma Cutting, 160 amps TIG and 140 amps Stick Arc power, all from a 10A single phase plug. Designed for portable repair work and small workshop use, the ATP160 is ideal for a welding enthusiast or hobbyist requiring a compact machine for basic repairs and general light welding requirements. The ATP160 Plasma Plasma Cutter is ideal for cutting steel up to 6mm thick, with a severance cut of 8mm. With the 160A TIG, you can weld Steel, Chrome Moly, Stainless, Titanium, or any other metal that can be welded with DC output, up to 3mm thickness. The 15-160A DC Stick/Arc output, with easy Arc start function precision welding Arc control, and super smooth inverter stabilised welding characteristics, is capable of welding like a pro with arc electrodes up to 3.2mm / 12mm steel thickness.

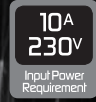

WORKSHOP SERIES

- ATP160 is the perfect choice for projects and repairs around the home, small workshop and auto repair tasks.
- Combination 3-in-1 multifunction Plasma Cutter/TIG Torch/ Stick Arc professional welding machine.
- Advanced IGBT technology, synergic controlled, very easy, precise and simple operation.
- Featured wave-form control system: perfect wave form of volts and amps during short circuits and Arc burning cycles.
- Automatic input voltage fluctuation controller, over-voltage protection, under voltage protection, over current protection, over load protection
- Automatic temperature control, fan on demand function
- Generators protected and optimised
- The ATP160 utilises cutting edge digital technology to deliver a flawless weld, making spatter and post-weld clean-up almost non-existent.



Specifications	
Supply Power Plasma Cutter	230V 60Hz / 10A Single Phase 10 - 30A
Welding current Output:	
TIG Torch	15A - 160A
STICK ARC	15A - 140A
Duty Cycle:	
Plasma Cutter	40% @30A, 100% @20A
TIG Torch	50% @ 160A, 112A @100%
STICK ARC	25% @140A
DC Open Circuit Voltage	58V
Efficiency	85%
Power factor	0.93
Cooling Method	Fan Cooled
Net Weight	16kg
Product Size	220x465x330mm
Package Weight	18kg

INCLUDES
5m Plasma Cutter Torch assembly,
4m (WP-17) TIG Torch Assembly,
4m 400A Electrode Holder with Cable,
3m 400A Earth Clamp with Cable,
2m Argon Gas Hose, Gas Regulator,
TIG Consumables Starter Kit
& Plasma Consumables Starter Kit.

160A

Welds up to 12mm
 Cuts up to 8mm

18 MONTH TRADE WARRANTY



With 10A Plug - Ideal for a welding enthusiast or hobbyist requiring a compact machine!

General Overview

The new digitally controlled ATP160 is a DC TIG, stick and plasma purpose unit, designed for portable repair work and small project use. It is ideal for the welding enthusiast or hobbyist with basic non aluminum repair needs and general light welding requirements. The ATP160 features a lightweight IGBT inverter design and can provide capable service for small projects and repairs. The ATP160 is not intended for use in production or for heavy fabrication chores. **NOTE: This unit is not suitable for welding aluminum.**

General Use and Care: Care should be taken to keep the unit out of direct contact with water spray. The unit is rated IP21S, which rates it for light contact with dripping water but should never be used in the presence of water for safety. It is a good idea to remove the welder from the vicinity of any water or moisture source to reduce the possibility of electrocution or shock. Never operate in standing water.

Every 1-2 months, depending upon use, the welder should be unplugged, opened up and carefully cleaned with compressed air. Regular maintenance will extend the life of the unit.

IMPORTANT: Before opening the unit's case for any reason, make sure the unit has been unplugged for at least 10 minutes to allow time for the capacitors to fully discharge. Severe shock and/or death could occur.

Do not restrict air flow or movement of air around the welder. Allow a buffer distance of 60cm (2ft) from all sides if possible, with a minimum distance of at least 45cm (18") clearance. Do not operate the welder immediately in the weld area or the force of the fan will cause welding issues such as unstable arc, or porosity.

Do not mount in areas that are prone to severe shock or vibration. Lift and carry the welder by the handle.

Do not direct metallic dust or any dirt intentionally toward the machine, particularly in grinding and welding operations. Make sure the panel is protected from damage during welding and cutting operations.



Duty Cycle. This unit can be described as a general purpose, do it yourself type of multi process unit and is intended for hobby use and general small repair and build activities. Care should be taken not to exceed the duty cycle limit of the ATP160 for maximum service life.

Once the duty cycle has been exceeded, heat may continue to build in the electronics. The duty cycle is based off a 10 minute duty cycle rating at 40° C. This means that the unit is capable of being operated at the maximum amps for the stated percent of time out of 10 minutes without a cool down break. For the balance of the 10 minute time period, the welder should rest without welding or cutting for maximum service life. The temperature light will come on and the welder will automatically stop welding or cutting when an overheat condition has occurred. If this occurs, stop and allow the unit to cool while switched on. Heat will continue to be generated by and transferred to the electronics after welding has ceased. Welding in humid, or hot conditions can affect duty cycle as well. Do not turn off the overheated welder until it has safely cooled for at least 15 minutes. Once the overheated condition has had time to clear, cycle the power switch off and back on to reset the unit. Do not operate the welder with the covers removed.

Over Current. Over currents can occur if there is a fault in the power supply system or inside the unit. If this occurs, and the LED lights up, turn the unit off, check for external causes and remedy the problem. If none is found, cycle the power switch off and then back on. If the over current light does not clear after cycling the power switch, contact Maintenance personnel for trouble shooting.

Blow Back and High Frequency Start. The welder uses High Frequency to start the TIG arc. HF is generated by a point gap system similar to an older automotive point/ coil system. A slight buzz, or hiss may be heard immediately upon start as the HF energizes. A bright blue light may be emitted from the front or side panel as the spark energizes. This is normal and safe as long as the covers are in place. Do not activate the HF unless you are in position and ready to weld to minimize point gap wear. Point gap should measure between 0.030"-0.045". The Plasma cutting torch is an improved blowback design which eliminates the need for High Frequency and its function is not dependent upon the HF points or point gap adjustment. Compared to older TIG/Stick Plasma designs, this helps to reduce point gap wear issues.

This manual has been compiled to give an overview of operation and is designed to offer information centered around safe, practical use of the welder. Welding is inherently dangerous. Only the operator of this welder, can ensure that safe operating practices are followed, through the exercise of common sense practices and training. Do not operate this machine until you have fully read the manual, including the safety section.

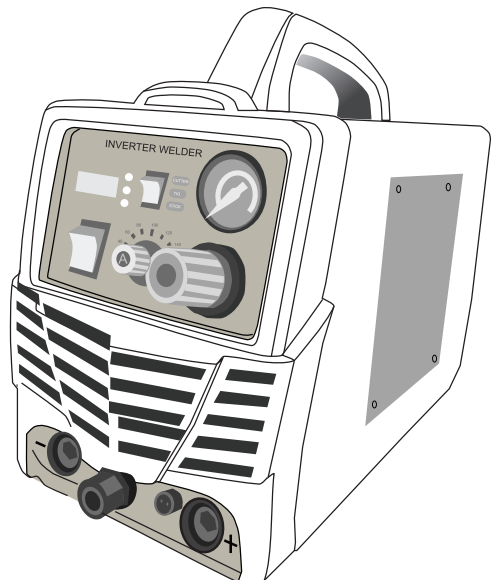

Specifications

ATP160 (230V)

Welding current Range(A)	Plasma Cutter	10-30A 230V
	TIG	15-160A 230V
	MMA (stick)	15-140A 230V
Nominal DC Open Circuit Voltage (OCV)		58V
Welding Output (230V)	Plasma Cutter	30A/92V
	TIG	160A/16.4V
	MMA (stick)	140A/25.6V
Rated Input Current(A)	Plasma Cutter	10A 230V
	TIG	10A 230V
	MMA (stick)	10A 230V
Duty Cycle (%)	Plasma Cutter	40% @30A 100% @20A
	TIG	50% @160A 100% @112A
	MMA (stick)	25% @140A 100% @70A
Efficiency		85%
Power factor		0.93
Welder Type		Plasma Cutter/STICK/TIG WELDER
Output Terminal Type		15-26 Dinse Style Connector
Number of phases		Single Phase
Nominal supply Voltage		230V
Nominal Supply Frequency		50Hz
Cooling Method		Fan Cooled
Net Weight		18kg
Dimensions (Height*Width*Depth)		22x46.5x33CM

Box contents

- ATP160 Plasma Cutter Cutter/TIG/Stick/Arc 3-in-1 Welding Machine.
- 4 Meter Professional Plasma Cutter Torch with accessories.
- 4 Meter Professional TIG Torch.
- 3 Meter Electrode Holder with Cable.
- 3 Meter Work Clamp with Cable.
- 2 Pieces of Tungsten Electrode 1.6mm.
- 2 Pieces of Tungsten Electrodes 2.4mm.
- 2 pieces of Electrode 3.2mm.
- 2 pieces of Electrode 2.4mm.
- 1 piece of Argon regulator.
- Owner's Manual.



Know your machine

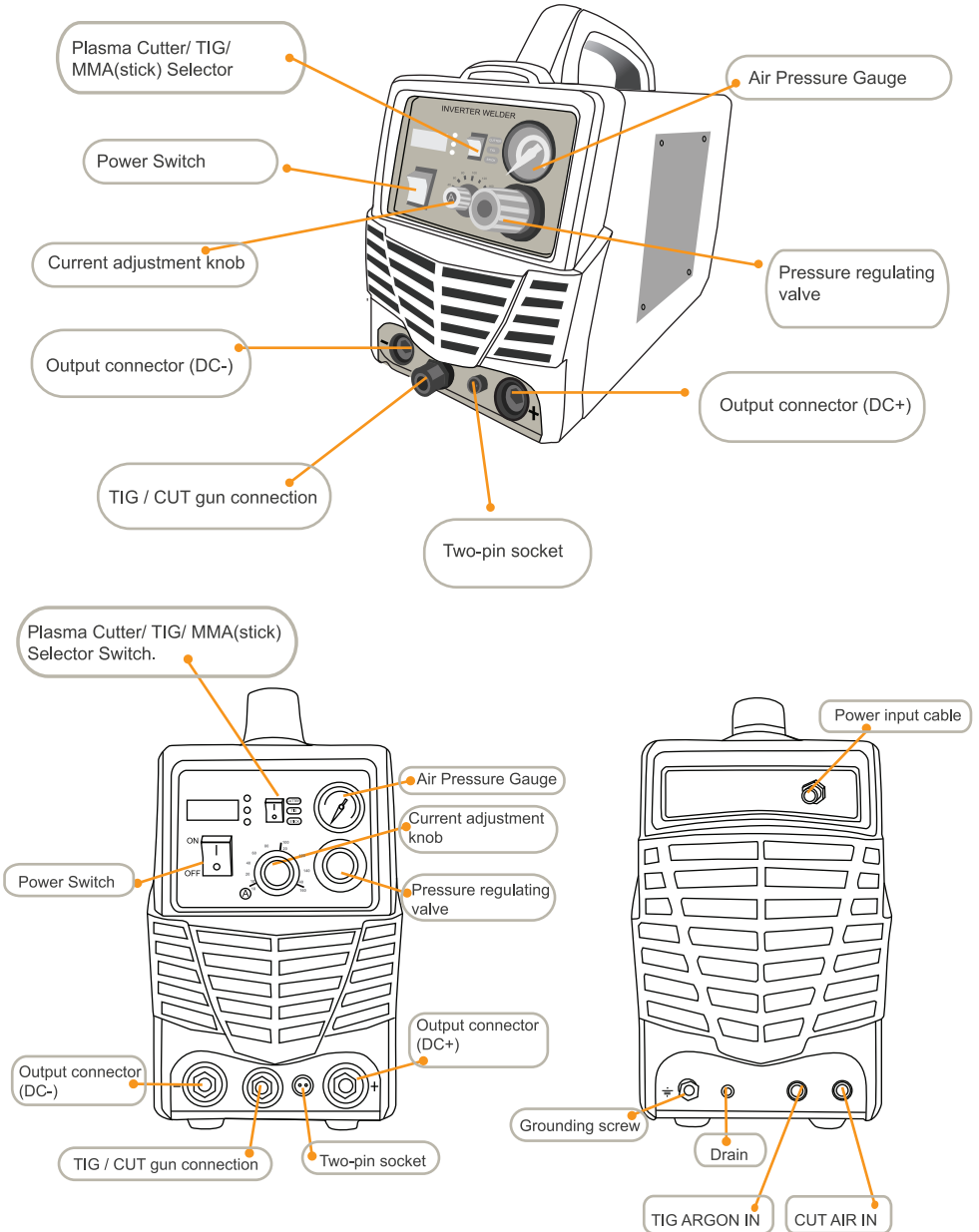

QUICK SETUP GUIDE: REAR CONNECTIONS FOR PLASMA OPERATION Compressor and Dryer Diagram

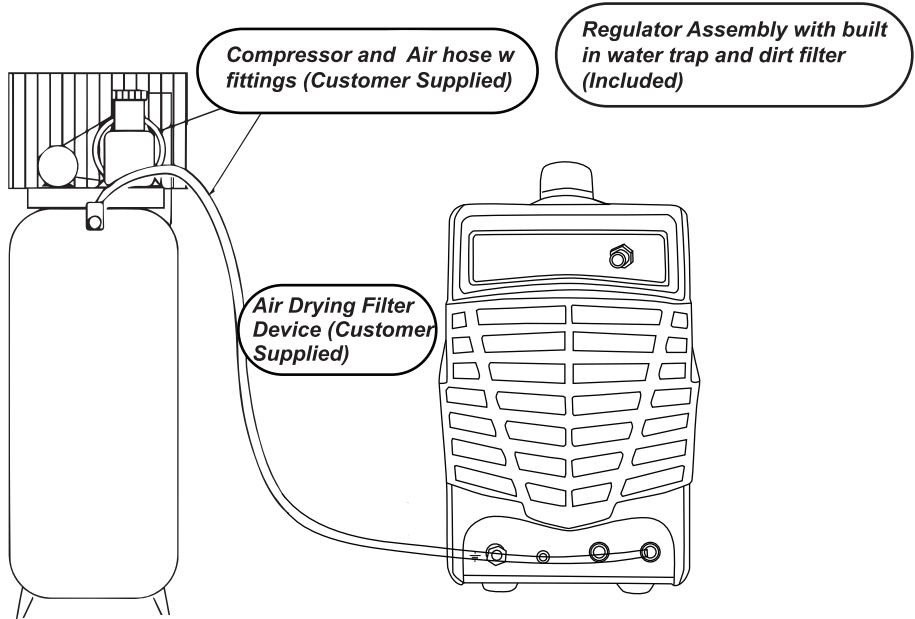

Please Note: Plasma cutters require a dry, moisture free air supply. Ensure you have a dessicant dryer/filter or electric air drying system in place. Damage/faults caused due to moisture in the air supply will not be covered under the warranty of this machine.

PT-31 PLASMA TORCH

PLASMA TORCH: PT-31



NO.	Description	Part Number	QTY
1	O-Ring	WT45065	2pk
2	Electrode - Std.	WT-WT18205	5pk
3	Swirl Ring	WT-WT18785	2pk
4	Std. Cutting Tip	WT-WT18866	5pk
5	Shield Cap	WT-WT18204	2pk

Plasma Cutting Guide

Amperage Guide

Material Thickness (mm)	0.5	2	4	6	8	10
Output Current Setting (A)	15	20	30	35	40	40

Effect of Cutting Speed

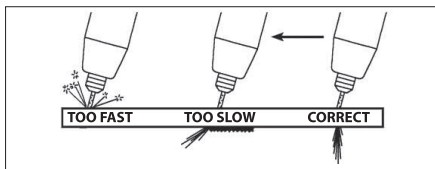

Piercing Technique

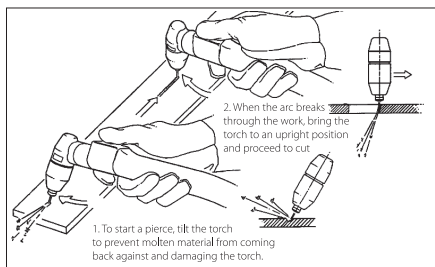

NOTE: Keep moving while cutting. Cut at a steady speed without pausing. Maintain the cutting speed so that the arc lag is 10° to 20° behind the travel direction. Use a 5° - 15° leading angle in the direction of the cut.

Operating Techniques

1. Piercing - Materials (up to 3.2mm/1/8in. thick) may be pierced with the torch touching the work. When piercing thicker materials, position the torch 0.5mm (0.2") above the work piece.

It is advisable when piercing thicker materials to drill a small pilot/starting hole in the work piece which makes it a lot easier and gives increased tip life. Start the cutting arc, then immediately raise the torch to 1.6mm (1/16") stand-off and move the torch along the cut path. This will reduce the chance of spatter from entering the torch and prevent the possibility of welding the tip to the plate. The torch should be angled at about 30° when starting to pierce, and then straightened after accomplishing the pierce.

- 2. Grate Cutting** - For rapid restarts, such as grate or heavy mesh cutting, do not release the torch switch. This avoids the 2 second pre-start portion of the cutting cycle.
- 3. Edge Starting** - For edge starts, hold the torch perpendicular to the work piece with the front of the tip near (not touching) the edge of the work piece at the point where the cut is to start. When starting at the edge of the plate, do not pause at the edge and force the arc to 'reach' for the edge of the metal.

NOTE: The speeds given here are typical for best quality cuts. Your actual speeds may vary depending on material composition, surface condition, operator technique, etc.

If cutting speed is too fast, you may lose the cut. With slower speeds excessive dross may accumulate. If speed is too slow, the arc may extinguish. Air cutting typically produces a rough face on stainless steel and aluminium.

- 4. Drag Cutting** - Position torch tip slightly above work piece, press torch switch and lower torch tip forward work piece until contact is made and cutting arc is established. After cutting arc is established, move the torch in the desired direction keeping the torch tip slightly angled, maintaining contact with the work piece.

Avoid moving too fast as would be indicated by sparks radiating from the topside of the work piece. Move the torch just fast enough to maintain sparks concentration at the underside of the work piece and making sure the material is completely cut through before moving on. Adjust drag speed as desired/ required.

- 5. Direction of Cut** - The plasma gas stream swirls as it leaves the torch to maintain a smooth column of gas. This swirl effect results in one side of a cut being more square than the other. Viewed along the direction of travel, the right side of the cut is more square than the left.

Establish the Cutting Arc as Quickly as Possible.

Cutting Speed Guide		
Material	Thickness (mm)	Cutting Speed (mm/s)
Carbon Steel (AISI 1020)	1.6	150
	3.2	50
	6.4	20
Stainless Steel (AISI 304)	1.6	140
	3.2	40
	6.4	15
Aluminium (6061)	1.6	190
	3.2	85
	6.4	30

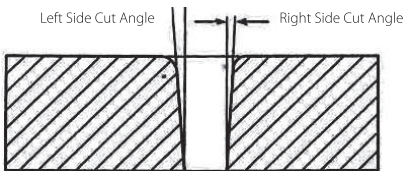

To make a square-edged cut along an inside diameter of a circle, the torch should move counter clockwise around the circle. To keep the square edge along an outside diameter cut, the torch should travel in a clockwise direction.

6. Quality Cuts – Dross (slag) is the excess material that spatters and builds up on the underside of the work-piece as you cut. Dross occurs when the operating procedure and technique is less than optimal. It will require practice and experience to obtain cuts without dross. Although less than optimal cuts will contain dross, it is relatively easy to remove by breaking it off using pliers or chipping off with a chisel or scraping or grinding the finished cut as needed and is generally only a minor inconvenience.

A combination of factors contributes to the build-up of dross. They include; material type, material thickness, amperage used for the cut, speed of the torch across the work-piece, condition of the torch tip, input line voltage, air pressure, etc. Generally there is an inversely proportional relationship between output current and speed of cut. Do not use more output current than is necessary and adjust speed of cut toward minimizing dross build-up on underside of cut. Experiment with adjusting current and speed to minimize dross.

When dross is present on carbon steel, it is commonly referred to as either 'high speed, slow speed, or top dross'. Dross present on top of the plate is normally caused by too great a torch to plate distance.

'Top dross' is normally very easy to remove and can often be wiped off with a welding glove. 'Slow speed dross' is normally present on the bottom edge of the plate. It can vary from a light to heavy bead, but does not adhere tightly to the cut edge, and can be easily scraped off. 'High speed dross' usually forms a narrow bead along the bottom of the cut edge and is very difficult to remove. When cutting troublesome steel, it is sometimes useful to reduce the cutting speed to produce 'slow speed dross'. Any resultant clean up can be accomplished by scraping, not grinding.

TIG welding

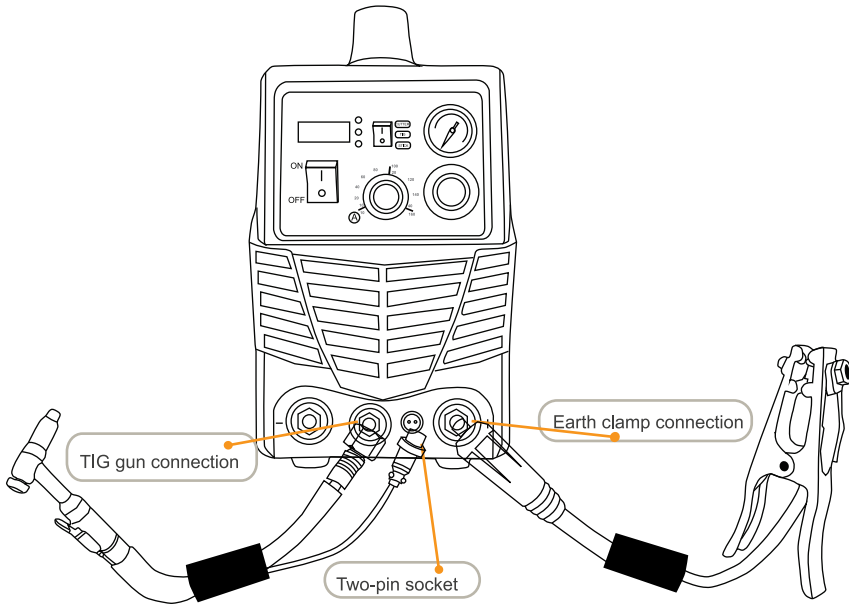

Please connect the earth clamp to the positive polarity, and the TIG welding torch to the negative polarity

1. Turn on the power switch at the front panel, digital current meter is normal, fan begins to rotate.
2. Open the valve of argon cylinder , adjust the volume of flow meter and make it is adequate to welding.
3. Press switch of torch, electromagnetic valve is started. Sound of HF arc striking can be heard, at the same time argon is flowing from torch burner.

NOTES:When welding is first operated, user must press switch of torch several seconds and begin to weld until all of air is be drained out. When welding is over, argon will still flow out in

several seconds in order to protect welding spot before cooled down. So torch must be kept welding place some time before arc has been extinguished.

4. Set suitable welding current and make sure welding current is adequate to thickness of work piece and process demand.

5. It is 2-4 mm from welding tungsten electrode to work piece, press control knob of torch, burn and strike arc, sound of HF arc-striking will be diminished. The welding machine can be operated now.

EXPANDED VIEW OF TIG TORCH

(Actual appearance may vary slightly from what is listed.)

TIG TORCH: 38419

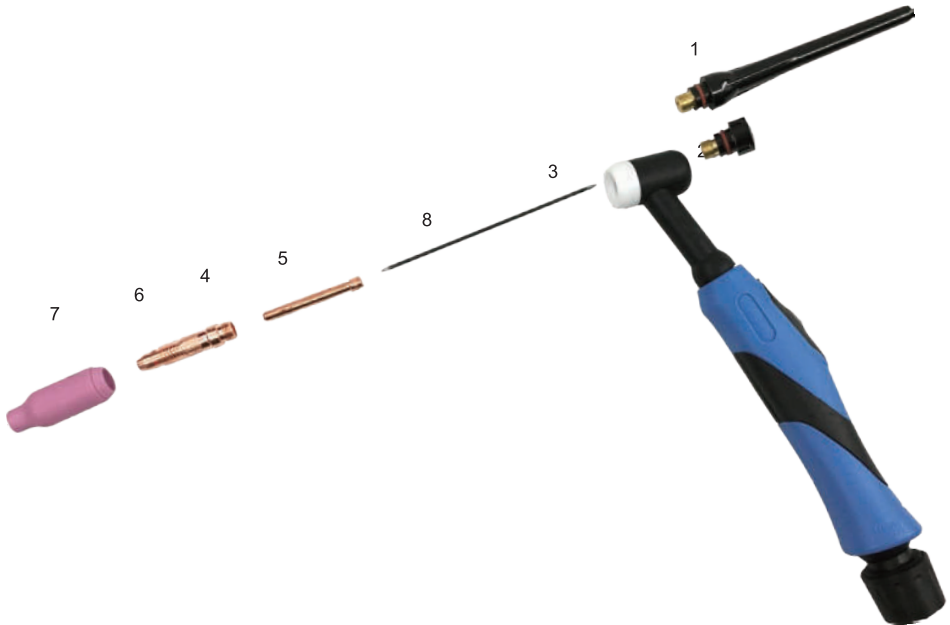

NO.		QTY
1	Long Back Cap with O-Ring	1
2	Short Back Cap	Opt.
3	Torch Head	1
4	Insulator	1
5	Collet 1/16" , 5/64" or 3/32"	1
6	Collet Holder	1
7	Ceramic Cup #4,5, or 6	1
8	Tungsten	4

TIG Basic Welding Guide

TIG Welding is a fusion procedure that uses an electric ARC created between an infusible tungsten electrode and base material to be welded. For TIG welding an inert gas must be used (Argon) which protects the welding bead. If filling material is used, it is made up of rods suitable to the material to be welded (steel, stainless steel, copper etc).

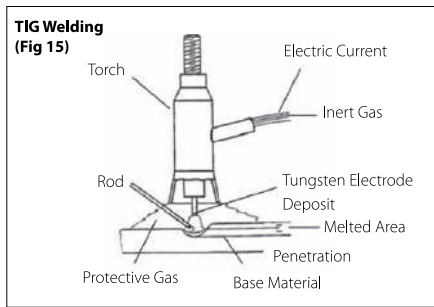

In TIG mode, welding is possible in all positions: flat, angle, on the edge, vertical and overhead. Furthermore, with respect to other types of welding, the welding joint has greater mechanical resistance, greater corrosion resistance and limited heating in the welded area which limits distortion. Welding can be done even without weld material, guaranteeing a smooth, shiny weld with no impurities or slag.

Tig Electrode Selection and Preparation

Electrode Polarity

Connect the TIG torch to the negative (-) torch terminal and the work lead to the positive (+) work terminal for direct current straight polarity. Direct current straight polarity is the most widely used polarity for DC TIG welding. It allows limited wear of the

Tungsten Electrode Types			
Electrode Type (Ground Finish)	Application	Features	Colour Code
Thoriated 2%	DC welding of mild steel, stainless steel and copper.	Excellent arc starting; long life; high current capacity.	Red
Ceriated 2%	DC welding of mild steel, stainless steel and copper.	Longer life; more stable arc; easier starting; wider current range; narrower, more concentrated arc.	Grey

electrode since 70% of the heat is concentrated at the work piece.

Tungsten Electrode Current Ranges	
Electrode Diameter	DC Current (Amps)
1.0mm (0.040")	30 - 60
1.6mm (1/16")	60 - 115
2.4mm (3/32")	100 - 165
3.2mm (1/8")	135 - 200
4.0mm (5/32")	190 - 280
4.8mm (3/16")	250 - 340

Guide For Selecting Filler Wire Diameter	
Filler Electrode Diameter	DC Current (Amps)
1.6mm (1/16")	20 - 90
2.4mm (3/32")	65 - 115
3.2mm (1/8")	100 - 165
4.8mm (3/16")	200 - 350

Preparing Tungsten for DC Electrode Negative (DCEN) Welding

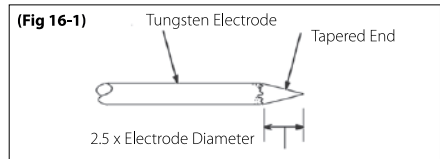

2.5 x Electrode Diameter

Grind end of tungsten on fine grit, hard abrasive wheel before welding. Do not use wheel for other jobs or tungsten can become contaminated causing lower weld quality.

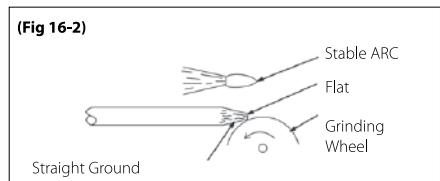

Ideal Tungsten Preparation - Stable ARC

Diameter of the flat determines amperage capacity.

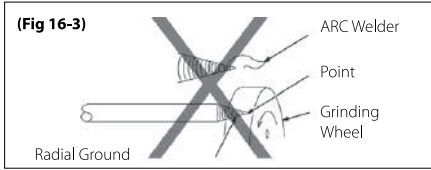

Wrong Tungsten Preparation - Wandering ARC
Diameter of the flat determines amperage capacity.

Shielding Gas Selection	
Aloy	Shielding Gas
Carbon Steel	Welding Argon
Stainless Steel	Welding Argon
Nickel Alloy	Welding Argon
Copper	Welding Argon
Titanium	Welding Argon

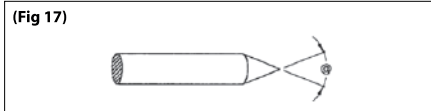

Pointing the Electrode
The electrode should be pointed according to the welding current.

Electrode Angles	
Angle @	Range of Current (Amps)
30°	0 - 30
60-90°	30 - 120
90-120°	120 - 250
120°	> 250

TIG Welding Parameters for Steel						
Base Metal Thickness	DC Current for Mild Steel	DC Current for Stainless Steel	Tungsten Electrode Diameter	Filler Rod Diameter (if required)	Argon Gas Flow Rate L/min	Joint Type
1.0mm (0.040")	35 - 45	20 - 30	1.0mm (0.040")	1.6mm (1/16")	5 - 7	Butt / Corner
	40 - 50	25 - 35				Lap / Fillet
1.2mm (0.045")	45 - 55	30 - 45	1.0mm (0.040")	1.6mm (1/16")	5 - 7	Butt / Corner
	50 - 60	35 - 50				Lap / Fillet
1.6mm (1/16")	60 - 70	40 - 60	1.6mm (1/16")	1.6mm (1/16")	7	Butt / Corner
	70 - 90	50 - 70				Lap / Fillet
3.2mm (1/8")	80 - 100	65 - 85	1.6mm (1/16")	2.4mm (3/32")	7	Butt / Corner
	90 - 115	90 - 110				Lap / Fillet
4.8mm (3/16")	115 - 135	100 - 125	2.4mm (3/32")	3.2mm (1/8")	10	Butt / Corner
	140 - 165	125 - 150				Lap / Fillet
6.4mm (1/4")	160 - 175	135 - 160	3.2mm (1/8")	4.0mm (5/32")	10	Butt / Corner
	170 - 200	160 - 180				Lap / Fillet

TIG Welding Troubleshooting

Troubleshooting - TIG Weld Quality		
Fault	Cause	Remedy
Excessive beard build up or poor penetration or poor fusion at edges of weld.	Welding current is too low.	Increase weld current and/or faulty joint preparation.
Weld bead too wide and flat or undercut at edges of weld or excessive burn through.	Welding current is too high.	Decrease weld current.
Weld bead too small or insufficient penetration or ripples in bead are widely spaced apart.	Travel speed too fast.	Decrease weld current.
Weld bead too wide or excessive bead build up or excessive penetration in butt joint.	Travel speed too fast.	Increase travel speed.
Uneven leg length in fillet joint.	Wrong placement of filler rod.	Re-position filler rod.
Electrode melts or oxidises when an arc is struck.	Torch lead connected to positive welding terminal.	Connect torch lead to negative welding terminal.
	No gas flowing to welding region.	Check the gas lines for kinks or breaks and gas cylinder contents.
	Torch is clogged with dust or dirt.	Clean torch.
	Gas hose is cut.	Replace gas hose.
	Gas passage contains impurities.	Disconnect gas hose from the rear of Power Source then raise gas pressure and blow out impurities.
	Gas regulator turned off.	Turn on.
	Torch valve is turned off.	Turn on.
Dirty weld pool	The electrode is too small for the welding current.	Increase electrode diameter or reduce the welding current.
	Electrode contaminated by contact with work piece or filler rod material.	Clean the electrode by grinding off any contaminants.
	Work piece surface has foreign material on it.	Clean surface.
Poor weld finish	Gas contaminated with air.	Check gas lines for cuts and loose fitting or change gas cylinder.
	Inadequate shielding gas.	Increase gas flow or check gas line for gas flow problems.
Arc start is not smooth.	Tungsten electrode is too large for the welding current.	Select the right size electrode.
	The wrong electrode is being used for the welding job.	Select the right electrode type.
	Gas flow rate is too high.	Select the right rate for the welding job.
	Incorrect shielding gas is being used.	Select the right shielding gas.
	Poor Work Lead/Clamp connection to work piece.	Improve connection to work piece.
Arc flutters during TIG welding.	Tungsten electrode is too large for the welding current.	Select the right size electrode.

MMA (Stick) Welding

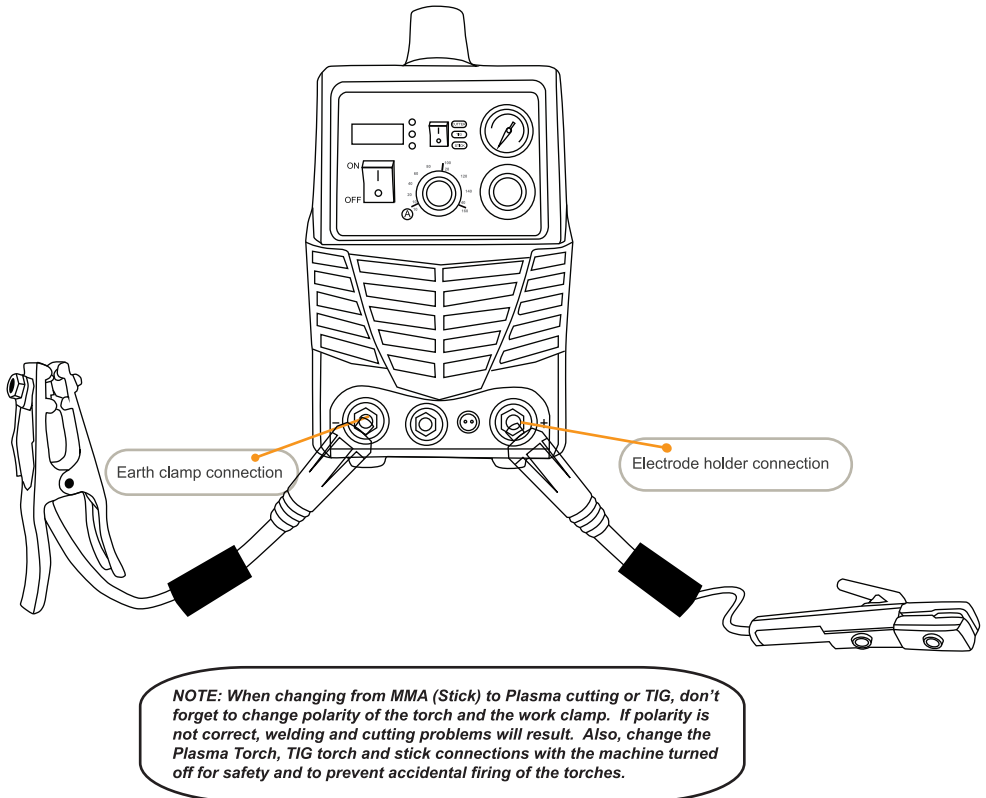

Please connect the electrode holder to the positive polarity and the earth clamp to the negative polarity, which is commonly used for MMA (Stick) welding on most materials, such as low carbon steel and low alloy steel.

3. Make sure welding current is adequate to thickness of work piece.

1. Activate power switch on front panel, fan will begin to work.

2. Make sure the function switch of front panel is on arc setting.

MMA (Stick) Basic Welding Guide

Size of Electrodes

The electrode size is determined by the thickness of metals being joined and can also be governed by the type of welding machine available. Small welding machines will only provide current (amperage) to run smaller sized electrodes.

For thin sections, it is necessary to use smaller electrodes otherwise the arc may burn holes through the job. A little practice will soon establish the most suitable electrode for a given application.

Storage of Electrodes

Always store electrodes in a dry place and in their original containers.

Electrode Polarity

Electrodes are generally connected to the electrode holder with the electrode holder connected positive polarity.

The work lead is connected to the negative polarity and is connected to the work piece. If in doubt consult the electrode data sheet.

Effects of MMA(Stick) Welding on Various Materials

High Tensile and Alloy Steels

The two most prominent effects of welding these steels are the formation of a hardened zone in the weld area, and, if suitable precautions are not taken, the occurrence in this zone of under-bead cracks. Hardened zone and underbead cracks in the weld area may be reduced by using the correct electrodes, preheating, using higher current settings, using larger electrodes sizes, short runs for larger electrode deposits or tempering in a furnace.

Manganese Steels

The effect on manganese steel of slow cooling from high temperatures causes embrittlement. For this reason it is absolutely essential to keep manganese steel cool during welding by quenching after each weld or skip welding to distribute the heat.

Cast Iron

Most types of cast iron, except white iron, are weldable. White iron, because of its extreme brittleness,

Flat Position,
Down Hand Butt Weld
(Fig 1-11)

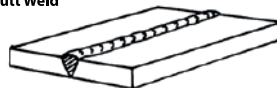

Flat Position,
Gravity Fillet Weld
(Fig 1-12)

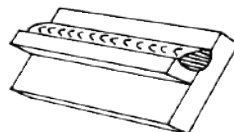

Horizontal Position,
Butt Weld
(Fig 1-13)

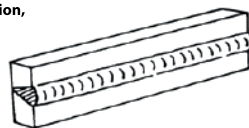

Horizontal-Vertical
(HV) Position
(Fig 1-14)

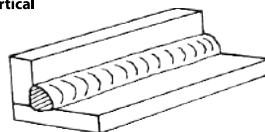

Vertical Position,
Butt Weld
(Fig 1-15)

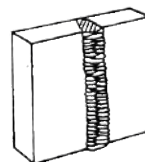

Vertical Position,
Fillet Weld
(Fig 1-16)

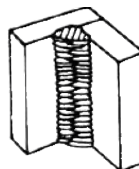

Overhead Position,
Butt Weld
(Fig 1-17)



Overhead Position,
Fillet Weld
(Fig 1-18)

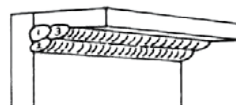

generally cracks when attempts are made to weld it. Trouble may also be experienced when welding white-heart malleable, due to the porosity caused by gas held in this type of iron.

Copper and Alloys

The most important factor is the high rate of heat conductivity of copper, making pre-heating of heavy sections necessary to give proper fusion of weld and base metal.

Types of Electrodes

Arc Welding electrodes are classified into a number of groups depending on their applications. There are a great number of electrodes used for specialised industrial purposes which are not of particular interest for everyday general work. These include some low hydrogen types for high tensile steel, cellulose types for welding large diameter pipes, etc. The range of electrodes dealt with in this publication will cover the vast majority of applications likely to be encountered; are all easy to use.

Electrodes for joining different metals:

MILD STEEL :

E6011 - This electrode is used for all-position welding or for welding on rusty, dirty, less-than-new metal. It has a deep, penetrating arc and is often the first choice for repair or maintenance work.

E6013 - This all-position electrode is used for welding clean, new sheet metal. Its soft arc has minimal spatter, moderate penetration and an easy-to-clean slag.

E7014 - All positional, ease to use electrode for use on thicker steel than E6013. Especially suitable for sheet metal lap joints, fillet welds and general purpose plate welding.

E7018 - A low-hydrogen, all-position electrode used when quality is an issue or for hard-to-weld metals. It has the capability of producing more uniform weld metal, which has better impact properties at low temperatures.

CAST IRON:

ENI-CL - Suitable for joining all cast irons except white cast iron.

STAINLESS STEEL:

E318L-16 - High corrosion resistances. Ideal for dairy work etc.

Joint Preparations

In many cases, it will be possible to weld steel sec-

tions without any special preparation. For heavier sections and for repair work on castings, etc., it will be necessary to cut or grind an angle between the pieces being joined to ensure proper penetration of the weld metal and to produce sound joints.

In general, surfaces being welded should be clean and free of rust, scale, dirt, grease, etc. Slag should be removed from oxy-cut surfaces. Typical joint designs are shown in Figure 1-19.

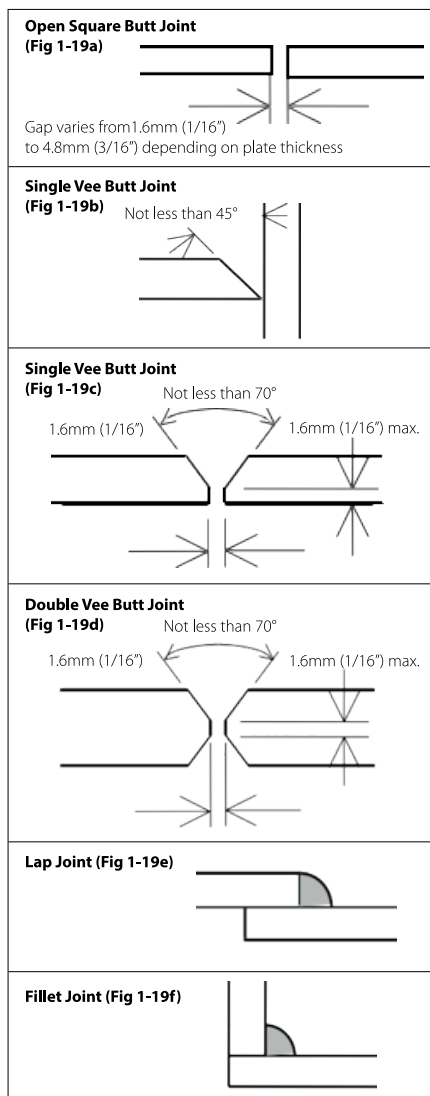

**Corner Weld
(Fig 1-19g)**

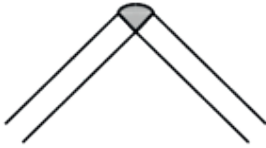

**Tee Joints
(Fig 1-19h)**

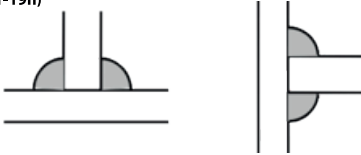

**Edge Joint
(Fig 1-19i)**

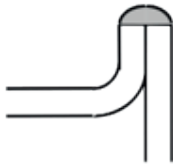

**Plug Welds
(Fig 1-19j)**



MMA Welding Techniques - A Word for Beginners

For those who have not yet done any welding, the simplest way to commence is to run beads on a piece of scrap plate. Use mild steel plate about 6.0mm thick and a 3.2mm electrode.

Clean any paint, loose scale or grease off the plate and set it firmly on the work bench so that welding can be carried out in the down hand position. Make sure that the Work Lead/Clamp is making good electrical contact with the work, either directly or through the work table. For light gauge material, always clamp the work lead directly to the job, otherwise a poor circuit will probably result.

The Welder

Place yourself in a comfortable position before beginning to weld. Get a seat of suitable height and do as much work as possible sitting down. Don't hold your body tense. A taut attitude of mind and a tensed body will soon make you feel tired. Relax and you will find that the job becomes much easier. You can add much to your peace of mind by wearing a leather apron and gauntlets. You won't be worrying then about being burnt or sparks setting alight to your clothes.

Place the work so that the direction of welding is across, rather than to or from, your body. The electrode holder lead should be clear of any obstruction so that you can move your arm freely along as the electrode burns down. If the lead is slung over your shoulder, it allows greater freedom of movement and takes a lot of weight off your hand. Be sure the insulation on your cable and electrode holder is not faulty; otherwise you are risking an electric shock.

Striking the Arc

Practice this on a piece of scrap plate before going on to more exacting work. You may at first experience difficulty due to the tip of the electrode "sticking" to the work piece. This is caused by making too heavy a contact with the work and failing to withdraw the electrode quickly enough. A low amperage will accentuate it. This freezing-on of the tip may be overcome by scratching the electrode along the plate surface in the same way as a match is struck. As soon as the arc is established, maintain a 1.6mm to 3.2mm gap between the burning electrode end and

the parent metal. Draw the electrode slowly along as it melts down.

Another difficulty you may meet is the tendency, after the arc is struck, to withdraw the electrode so far that the arc is broken again. A little practice will soon remedy both of these faults.

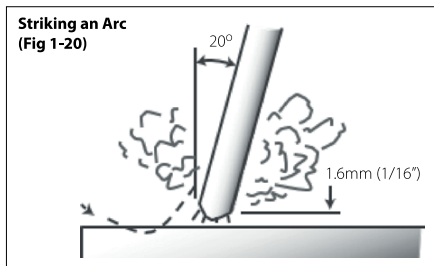

Arc Length

The securing of an arc length necessary to produce a neat weld soon becomes almost automatic. You will find that a long arc produces more heat.

A very long arc produces a crackling or spluttering noise and the weld metal comes across in large, irregular blobs. The weld bead is flattened and spatter increases. A short arc is essential if a high quality weld is to be obtained although if it is too short there is the danger of it being blanketed by slag and the electrode tip being solidified in. If this should happen, give the electrode a quick twist back over the weld to detach it. Contact or "touch-weld" electrodes such as E7014 Stick electrodes do not stick in this way, and make welding much easier.

Rate of Travel

After the arc is struck, your next concern is to maintain it, and this requires moving the electrode tip towards the molten pool at the same rate as it is melting away. At the same time, the electrode has to move along the plate to form a bead.

The electrode is directed at the weld pool at about 20° from the vertical. The rate of travel has to be adjusted so that a well-formed bead is produced.

If the travel is too fast, the bead will be narrow and strung out and may even be broken up into individual globules. If the travel is too slow, the weld metal piles up and the bead will be too large.

Making Welded Joints

Having attained some skill in the handling of an electrode, you will be ready to go on to make up welded joints.

A. Butt Welds

Set up two plates with their edges parallel, as shown in Figure 1-21, allowing 1.6mm to 2.4mm gap between them and tack weld at both ends. This is to prevent contraction stresses from the cooling weld metal pulling the plates out of alignment.

Plates thicker than 6.0mm should have their mating edges bevelled to form a 70° to 90° included angle. This allows full penetration of the weld metal to the root. Using a 3.2mm E7014 Stick electrode at 100 amps, deposit a run of weld metal on the bottom of the joint.

Do not weave the electrode, but maintain a steady rate of travel along the joint sufficient to produce a well-formed bead. At first you may notice a tendency for undercut to form, but keeping the arc length short, the angle of the electrode at about 20° from vertical, and the rate of travel not too fast, will help eliminate this.

The electrode needs to be moved along fast enough to prevent the slag pool from getting ahead of the arc. To complete the joint in thin plate, turn the job over, clean the slag out of the back and deposit a similar weld.

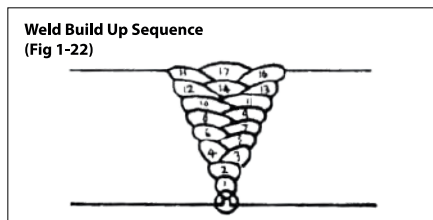
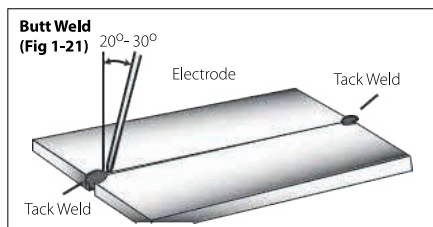

Heavy plate will require several runs to complete the joint. After completing the first run, chip the slag out and clean the weld with a wire brush. It is important to do this to prevent slag being trapped by the second run. Subsequent runs are then deposited using either a weave technique or single beads laid down in the sequence shown in Figure 1-22. The width of weave should not be more than three times the core wire diameter of the electrode.

When the joint is completely filled, the back is either machined, ground or gouged out to remove slag which may be trapped in the root, and to prepare a suitable joint for depositing the backing run. If a backing bar is used, it is not usually necessary to remove this, since it serves a similar purpose to the backing run in securing proper fusion at the root of the weld.

B. Fillet Welds

These are welds of approximately triangular cross-section made by depositing metal in the corner of two faces meeting at right angles. Refer to Figure 1-14, 1-23 and 1-24.

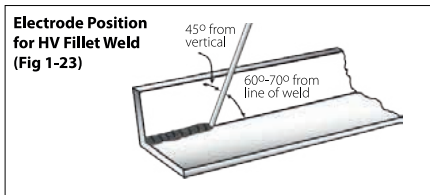

A piece of angle iron is a suitable specimen with which to begin, or two lengths of strip steel may be tacked together at right angles. Using a 3.2mm E7014 Stick electrode at 100 amps, position angle iron with one leg horizontal and the other vertical. This is known as a horizontal-vertical (HV) fillet.

Strike the arc and immediately bring the electrode to a position perpendicular to the line of the fillet and about 45° from the vertical. Some electrodes require being sloped about 20° away from the perpendicular position to prevent slag from running ahead of the weld. Refer to Figure 1-23.

Do not attempt to build up much larger than 6.4mm width with a 3.2mm electrode, otherwise the weld metal tends to sag towards the base, and undercut forms on the vertical leg. Multi-runs can be made as shown in Figure 1-24. Weaving in HV fillet welds is undesirable.

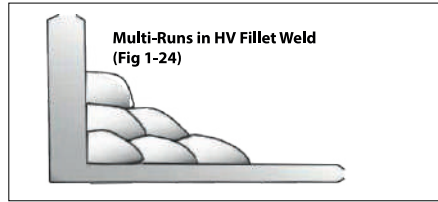

C. Vertical Welds

1. Vertical Up

Tack weld a three feet length of angle iron to your work bench in an upright position. Use a 3.2mm E7014 Stick electrode and set the current at 100 amps. Make yourself comfortable on a seat in front of the job and strike the arc in the corner of the fillet. The electrode needs to be about 10° from the horizontal to enable a good bead to be deposited. Refer Fig. 1-25.

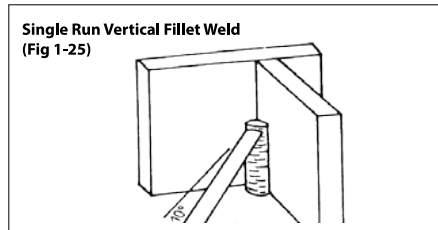

Use a short arc, and do not attempt to weave on the first run. When the first run has been completed deslag the weld deposit and begin the second run at the bottom. This time a slight weaving motion is necessary to cover the first run and obtain good fusion at the edges.

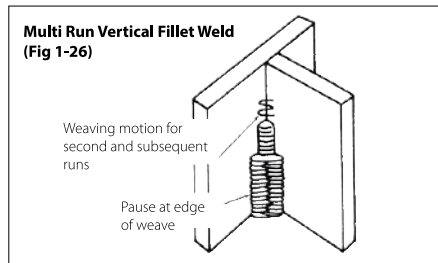

At the completion of each side motion, pause for a moment to allow weld metal to build up at the edges, otherwise undercut will form and too much metal will accumulate in the centre of the weld. Figure 1-26 illustrates multi-run technique and Figure 1-27 shows the effects of pausing at the edge of weave and of weaving too rapidly.

Examples of Vertical Fillet Welds (Fig 1-27)

CORRECT



Pause at edge of weave allows weld metal to build up and eliminates undercut

INCORRECT



Note: Weld contour when insufficient pause at edge of weave

2. Vertical Down

The E7014 Stick electrode makes welding in this position particularly easy. Use a 3.2mm electrode at 100 amps. The tip of the electrode is held in light contact with the work and the speed of downward travel is regulated so that the tip of the electrode just keeps ahead of the slag. The electrode should point upwards at an angle of about 45°.

3. Overhead Welds

Apart from the rather awkward position necessary, overhead welding is not much more difficult than down hand welding. Set up a specimen for overhead welding by first tacking a length of angle iron at right angles to another piece of angle iron or a length of

waste pipe. Then tack this to the work bench or hold in a vice so that the specimen is positioned in the overhead position as shown in the sketch.

The electrode is held at 45° to the horizontal and tilted 10° in the line of travel (Figure 1-28). The tip of the electrode may be touched lightly on the metal, which helps to give a steady run. A weave technique is not advisable for overhead fillet welds.

Use a 3.2mm E6013 Stick electrode at 100 amps, and deposit the first run by simply drawing the electrode along at a steady rate. You will notice that the weld deposit is rather convex, due to the effect of gravity before the metal freezes.

Overhead Fillet Weld (Fig 1-28)

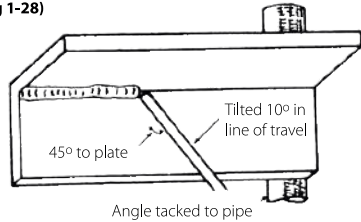

MMA (Stick) Troubleshooting

Fault	Cause	Remedy
A gap is left by failure of the weld metal to fill the root of the weld.	Welding current too low.	Increase welding current.
	Electrode too large for joint.	Use smaller diameter electrode.
	Insufficient gap.	Allow wider gap.
Non-metallic particles are trapped in the weld metal.	Non-metallic particles may be trapped in undercut from previous run.	If a bad undercut is present clean slag bout and cover with a run from a smaller gauge electrode.
	Joint preparation too restricted.	Allow for adequate penetration and room for cleaning out the slag.
	Irregular deposits allow slag to be trapped.	If very bad, chip or grind out irregularities.
	Lack of penetration with slag trapped beneath weld bead.	Use smaller electrode with sufficient current to give adequate penetration. Use suitable tools to remove all slag from corners.
	Rust or mill scale is preventing full fusion.	Clean joint before welding.
	Wrong electrode for position in which welding is done.	Use electrodes designed for position in which welding is done, otherwise proper control of slag is difficult.
<p>Figure 1: Example of insufficient gap or incorrect sequence</p> <p>Incorrect Sequence</p> <p>Insufficient Gap</p>		
A groove has been formed in the base metal adjacent to the toe of a weld and has not been filled by the weld metal (undercut).	Welding current is too high.	Reduce welding current.
	Welding arc is too long.	Reduce the length of the welding arc.
	Angle of the electrode is incorrect.	Electrode should not be inclined less than 45° to the vertical face.
	Joint preparation does not allow correct electrode angle.	Allow more room in joint for manipulation of the electrode.
	Electrode too large for joint.	Use smaller gauge electrode.
	Insufficient deposit time at edge of weave.	Pause for a moment at edge of weave to allow weld metal build-up.
	Power source is set for MIG (GMAW) welding.	Set power source to STICK (MMA) mode.
Portions of the weld run do not fuse to the surface of the metal or edge of the joint.	Small electrodes used on heavy cold plate.	Use larger electrodes and preheat the plate.
	Welding current is too low.	Increase welding current.
	Wrong electrode angle.	Adjust angle so the welding arc is directed more into the base metal.
	Travel speed of electrode is too high.	Reduce travel speed of electrode.
	Scale or dirt on joint surface.	Clean surface before welding.
<p>Figure 2: Example of Lack of Fusion</p> <p>Lack of fusion caused by dirt; electrode angle incorrect; rate of travel too high</p> <p>Lack of side fusion, scale dirt; small electrode; amperage too low</p> <p>Lack of inter-run fusion</p> <p>Lack of root fusion</p>		
Gas pockets or voids in weld metal (porosity)	High levels of sulphur in steel.	Use an electrode that is designed for high sulphur steels.
	Electrodes are damp.	Dry electrodes before use.
	Welding current is too high.	Reduce welding current.
	Surface impurities such as oil, grease, paint, etc.	Clean joint before welding.
	Welding in a windy environment.	Shield the weld area from the wind.
	Electrode damaged i.e. flux coating incomplete.	Discard damaged electrodes and only use electrodes with a complete flux coating.
Crack occurring in weld metal soon after solidification commences	Rigidity of joint.	Redesign to relieve weld joint of severe stresses or use crack resistance electrodes.
	Insufficient throat thickness.	Travel slightly slower to allow greater build up in throat.
	Weld current is too high.	Decrease welding current.
<p>Figure 3: Example of Slag Inclusion</p> <p>Not cleaned, or incorrect electrode</p> <p>Slag trapped in undercut</p> <p>Slag trapped in root</p>		

Care & Maintenance

Keep your Welding Machine in Top Condition

The ATP160 does not require any special maintenance, however the user should take care of the machine as follows:

- Regularly clean the ventilation slots.
- Keep the casing clean.
- Check all cables before use.
- Check electrode holders, work lead/clamps and welding torches before use.
- Replace worn electrode holders and earth clamps, which do not provide a good connection.
- Replace worn torch consumable parts in a timely manner.
- Replace worn wire drive components in a timely manner
- Use a soft cloth or brush to clean electrical components. Do not use liquid cleaning products, water or especially solvents.
- Do not use compressed air to clean electrical components as this can force dirt and dust further into components, causing electrical short circuits.
- Check for damaged parts. Do not use the welder with damaged parts.

If damaged, before further use, the welder must be carefully checked by a qualified person to determine that it will operate properly. Check for breakage of parts, mountings and other conditions that may affect its operation.

Have your welder repaired by an expert. An authorised service centre should properly repair a damaged part.

This appliance is manufactured in accordance with relevant safety standards. Only experts must carry out repairing of electrical appliances, otherwise considerable danger for the user may result. Use only genuine replacement parts. Do not use modified or non-genuine parts.

Storing the Welder

When not in use the welder should be stored in the dry and frost-free environment.



WARNING! Before performing cleaning/maintenance, replacing cables / connections, make sure the welding machine is switched off and disconnected from the power supply.



Accessories & Consumables

Visit www.weldtech.net.nz for a full range of consumables and accessories.

Knowledge & Resources

Please refer to Euroquip website www.euroquip.co.nz/Downloads.html for knowledgebase articles & operation videos.

Change filter operation

i THE AIR FILTER IS REQUIRED TO BE CHANGED ONCE EVERY THREE MONTHS.

1. Turn off the power and unplug the power cord.
2. Open the small side door of the machine and unplug the Pipe.
3. Remove the filter.

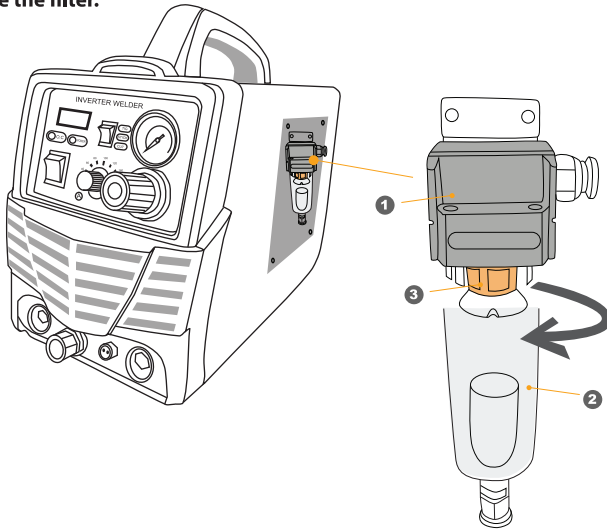

A Separate

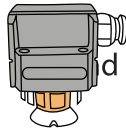

B Unscrew

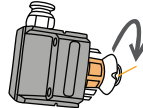

C Just need to change the Sintered Bronze Filter



Explosion Diagrams & Part List

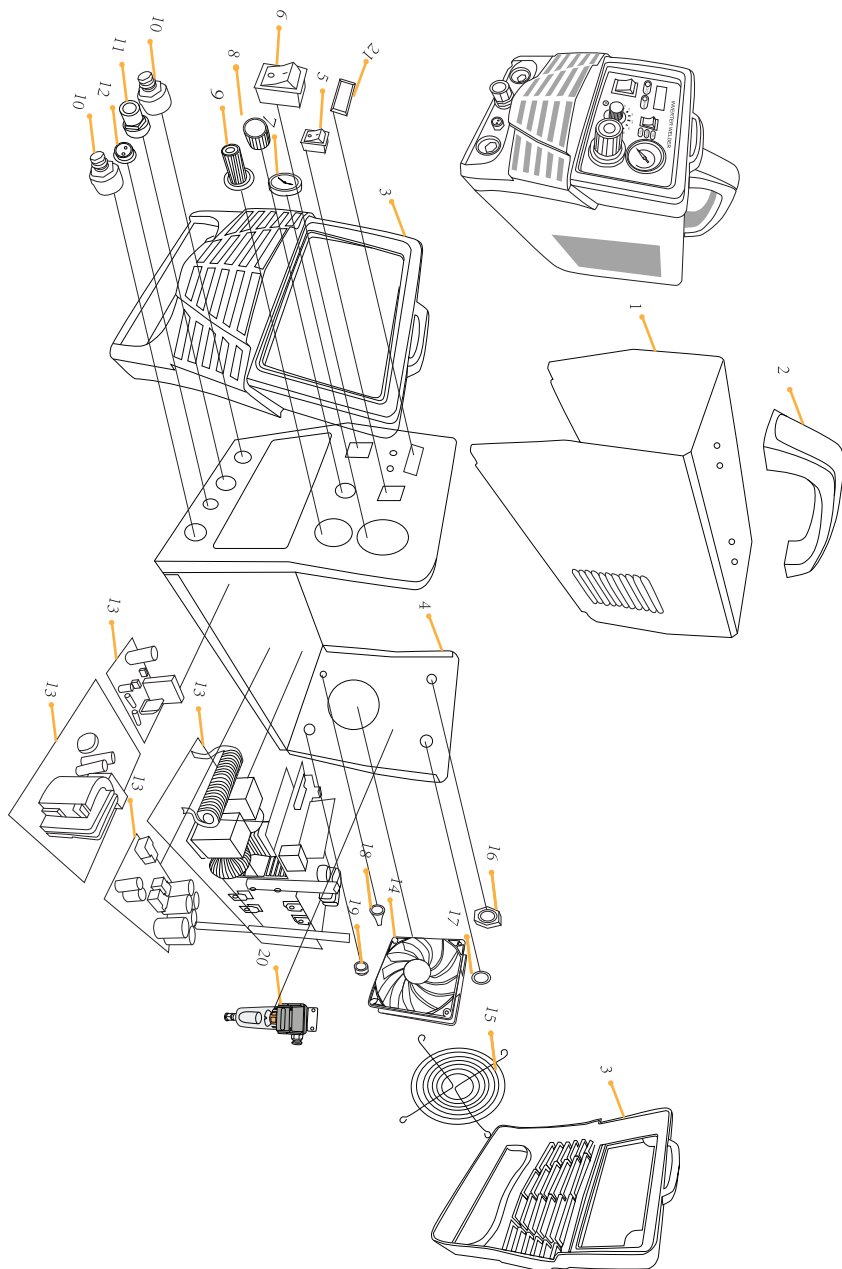

Part List

NO.	Description	NO.	Description
1	Housing	11	Gas-electric connector for CUT/TIG torch
2	Handle	12	Two-pin socket
3	Plastic front panel	13	Circuit Boards
4	Bottom housing	14	Fan
5	CUTTER/TIG/STICK switch	15	Fan External Cover
6	ON/OFF switch	16	Air supply connector
7	Air pressure gauge	17	Primary power input cable.
8	Current Adjustment Knob	18	Water drain
9	Air pressure regulator	19	Grounding screw
10	Output connector (DC + / -)	20	Air filter
		21	LED Meter

Safety Warning

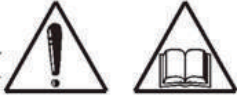

IMPORTANT: BEFORE INSTALLING, OPERATING OR CARRYING OUT MAINTENANCE ON THE PLASMA CUTTER, READ THE CONTENTS OF THIS MANUAL CAREFULLY, WHICH MUST BE STORED IN A PLACE FAMILIAR TO ALL USERS FOR THE ENTIRE OPERATIVE LIFE-SPAN OF THE MACHINE. PAY PARTICULAR ATTENTION TO THE SAFETY RULES. THIS EQUIPMENT MUST BE USED SOLELY FOR PLASMA CUTTING.

MACHINE OPERATING

Plasma cutting equipment can be dangerous to both the operator and people in or near the surrounding working area, if the equipment is not correctly operated. Equipment must only be used under the strict and comprehensive observance of all relevant safety regulations. Read and understand this instruction manual carefully before the installation and operation of this equipment.

⚠ WARNING

DANGER! People with pacemakers should not use this machine or be nearby during use. Plasma Cutter/TIG/Stick, such as this one, produce strong, fluctuating electromagnetic fields that can cause pacemaker interference or pacemaker failure. People with pacemakers should consult their physician(s) for advice.

Never leave the machine unattended when it is plugged into an electrical outlet.

Turn off the Plasma Cutter, and unplug it from its electrical outlet before leaving.

Unplug the machine from its electrical outlet before performing any inspection, maintenance, or cleaning procedures, including changing accessories.

Avoid unintentional starting. Make sure switch is in off position before plugging in. Make sure you are prepared to begin work before turning on the machine.



Electric shock: It can kill. Touching live electrical parts can cause fatal shocks or severe burns.

The plasma nozzle and work circuit is electrically live whenever the output is on.

The input power circuit and internal machine circuits are also live when power is on.

Do not touch live electrical parts or electrodes with bare skin, gloves or wet clothing.

Incorrectly installed or improperly grounded equipment is dangerous.

- Connect the primary input cable according to USA standards and regulations.
- Disconnect power source before performing any service or repairs.
- Avoid all contact with live electrical parts of the welding circuit, torch nozzle and work piece with bare hands. The operator must wear dry welding gloves while he/she performs the plasma cutting task.
- Isolate yourselves from both the earth and the work piece.
- Keep cords dry, free of oil and grease, and protected from hot metal and sparks.
- Frequently inspect input power cable for wear and tear, replace the cable immediately if damaged, bare wiring is dangerous and can kill.
- Do not use damaged, under sized, or badly joined cables.
- Do not drape cables over your body.
- We recommend (RCD) safety switch is used with this equipment to detect any leakage of current to earth.



Fumes and gases are dangerous. Plasma cutting/TIG/STICK produces fumes and gases. Harmful fumes and metallic powders are produced during the cutting operation. Metals which are painted or coated or which contain mercury, zinc, lead and graphite may produce harmful concentrations of toxic fumes during cutting. Breathing these fumes and gases can be hazardous to your health.

- Do not breathe the smoke and gas generated whilst welding or cutting, keep your head out of the fumes.
- Keep the working area well ventilated, use fume extraction or ventilation to remove welding fumes and gases.
- In confined or heavy fume environments always wear an approved air supplied respirator.
- Cutting fumes and gases can displace air and lower the oxygen level causing injury or death.
- Be sure the breathing air is safe.
- Do not cut in locations near degreasing, cleaning, or spraying operations. The heat and rays of the arc can react with vapours to form highly toxic and irritating gases.
- Materials such as galvanized, lead, or cadmium plated steel, containing elements that can give off toxic fumes when cutting. Do not cut these materials unless the area is very well ventilated, and or wearing an air supplied respirator.
- Always read the material Safety Data Sheets (MSDS) that should be supplied with the material you are using. These MSDSs will give you the information regarding the kind and amount of fumes and gases that may be dangerous to your health.



Arc rays: harmful to people's eyes and skin. Arc rays from the plasma cutting process produce intense visible and invisible ultraviolet and infrared rays that can burn eyes and skin. Protect your eyes with welding masks or goggles fitted with filtered lenses, and protect your body with appropriate safety garments. Protect others by installing adequate shields or curtains.

- Always wear a helmet or goggles with correct shade of filter lens and suitable protective clothing including welding gloves, apron, leg and foot protection whilst the plasma cutting operation is performed. Measures should be taken to protect people in or near the surrounding working area. Use protective screens or barriers to protect others from flash, glare and sparks; warn others not to watch the arc.

Fire hazard. Plasma cutting on closed containers, such as tanks, drums, or pipes, can cause them to explode. Flying sparks from the welding arc, hot work piece, and hot equipment can cause fires and burns. Accidental contact of electrode to metal objects can cause sparks, explosion, overheating, or fire. Check and be sure the area is safe before doing any cutting.

- The cutting sparks may cause fire, therefore remove any flammable materials well away from the working area.



Cover flammable materials and containers with approved covers if unable to be moved from the welding area.

- Do not Plasma Cut closed containers such as tanks, drums, or pipes, unless they are properly prepared according to the required Safety Standards to insure that flammable or toxic vapors and substances are totally removed, these can cause an explosion even though the vessel has been "cleaned". Vent hollow castings or containers before heating, cutting or welding. They may explode.
- Do not cut where the atmosphere may contain flammable dust, gas, or liquid vapours (such as petrol)
- Have a fire extinguisher nearby and know how to use it. Be alert that cutting sparks and hot materials from cutting can easily go through small cracks and openings to adjacent areas. Be aware that cutting on a ceiling, floor, bulkhead, or partition can cause fire on the hidden side.



Gas Cylinders. Do not cut in the vicinity of pressurised gas cylinders or in the presence of explosive dust, gases or fumes. Gas cylinders contain gas under high pressure. If damaged, a cylinder can explode. Because gas cylinders are normally part of the welding process, be sure to treat them carefully. CYLINDERS can explode if damaged.

proper cylinder care. Secure cylinders to a cart, wall, or post, to prevent them from falling. All cylinders should be used and stored in an upright position. Never drop or strike a cylinder. Do not use cylinders that have been dented. Cylinder caps should be used when moving or storing cylinders. Empty cylinders should be kept in specified areas and clearly marked "empty."

- Protect gas cylinders from excessive heat, mechanical shocks, physical damage, slag, open flames, sparks, and arcs.
- Insure cylinders are held secure and upright to prevent tipping or falling over.
- Never allow the plasma nozzle or earth clamp to touch the gas cylinder, do not drape welding cables over the cylinder.
- Never plasma cut on a pressurised gas cylinder, it will explode and kill you.
- Open the cylinder valve slowly and turn your face away from the cylinder outlet valve and gas regulator.



Electronic magnetic fields. The magnetic fields created by the high currents generated by plasma cutting may affect the operation of pacemakers and other vital electronic medical equipment.

- Wearers of Pacemakers and other Implanted Medical Devices should keep away.
- Implanted Medical Device wearers should consult their doctor and the device manufacturer before going near any electric welding, cutting or heating operation.



Noise can damage hearing. Noise from some processes or equipment can damage hearing. This machine does not directly produce noise exceeding 80dB. The plasma cutting/welding procedure may produce noise levels beyond said limit; users must therefore implement all precautions required by law. Wear approved ear protection if noise level is high.



Hot parts. Items being plasma cut generate and hold high heat and can cause severe burns. Do not touch hot parts with bare hands. Allow a cooling period before working on the plasma torch. Use insulated welding gloves and clothing to handle hot parts and prevent burns.

Warranty

As part of an on-going commitment to excellence in product support, Euroquip offers a comprehensive product warranty program.

Warranty period for the ATP160:

Commercial Use: 18 Month

Domestic Use: 18 Month

Warranty covers failure caused by manufacturing and material defects in the product, during the warranty period specified. The warranty period begins when the product is purchased by the end user. Warranty is not transferrable and is only claimable by the original purchaser.

Warranty does not cover parts that are subject to wear and tear from usage.

Warranty covers failure of a product caused by defective materials and/or manufacturing for the period given and the usage specified by Euroquip. The warranty period begins when the product is purchased by the end user. Warranty is not transferrable and is only claimable by the original purchaser.

Warranty also does not cover failure caused by the untimely replacement or service of the above wearing parts. Evidence must be provided that the product has been maintained and serviced suitably for a claim to be considered under warranty.

Failure caused by incorrect operation of the product, lack of proper care and maintenance of the product, external damage, external circumstances such as contaminated fuel or poor water supply, modifications to the product, attempted repair/ service by a party other than an Approved Service Agent, is not covered under warranty.

Warranty does not cover pre delivery service and adjustment, or failure that may occur as a result of lack of/ incorrect pre delivery service and adjustment.

Warranty does not cover any incidental, indirect or consequential loss, damage or expense that may result from any defect, failure or malfunction of a product.

Should any issue be found to be a combination of a warranty failure and a non-warranty issue, the repair cost component to rectify and repair the non-warranty failure is the customers' full responsibility.

The decision that an issue with a product qualifies as a warranty claim is made at the sole jurisdiction of Euroquip.

No costs incurred will be considered under warranty if repairs are carried out by a party other than a Euroquip Approved Service Agent, unless with prior consent in writing from Euroquip.

It is the responsibility of the purchaser to deliver a product under warranty to the nearest relevant service agent or product reseller. Warranty does not cover call outs, mileage and freight costs.

If a product is repaired under warranty, parts and labour required for the repair will be supplied at no charge. Warranty assessment and repair will be scheduled and executed according to the normal work flow at the service location and depending on the availability of suitable replacement parts.

This warranty policy is an additional benefit and does not affect the legal rights of any end user, reseller or service agent.



Congratulations on your new WELDTECH product. We are proud to have you as our customer and will strive to provide you with the best service and reliability in the industry. This product is backed by our extensive warranty and service network. To locate your nearest distributor or service agency visit www.weldtech.net.nz, or email us at customerservice@euroquip.co.nz

www.weldtech.net.nz