



EZIMIG215C

200A MIG/MMA WELDER

OPERATING INSTRUCTIONS



15 AMP
PLUG



CONSTANT
CURRENT/
VOLTAGE



DIRECT
CURRENT



LED
SCREEN



230V 50HZ
SINGLE
PHASE



SPOOL GUN
READY



INTELLIGENT
PROTECTION
SYSTEM



IGBT
INVERTER
TECHNOLOGY



SPIKE/
GENERATOR
SAFE



CORROSION
RESISTANT



EZIMIG215C

CONTENT

1 Overview	7
1.1 Brief Introduction.....	7
1 Operation	8
2.1 Machine Layout Description	8
2.2 Technical Data	10
2.3 Duty cycle and Over-heat	10
2.4 Working Principle	11
2.5 Volt-Ampere Characteristic.....	11
3 Installation & Operation	12
3.1 Installation & Operation for MIG Welding	12
3.1.1 Set up installation for MIG/MAG Welding.....	12
3.1.2 Wire Feed Roller Selection	15
3.1.3 Wire Installation and Set Up Guide	16
3.1.4 MIG Torch Liner Installation	19
3.1.5 MIG Torch Liner Types and Information	20
3.1.6 Torch & Wire Feed Set Up for Aluminium Wire	22
3.1.7 Set up installation for Spool Gun	24
3.1.8 MIG Torch /Spool Gun control	27
3.1.9 MIG Welding	29
3.2 Installation & Operation for Stick Welding	37
3.2.1 Set up installation for Stick Welding	37
3.2.3 Stick (MMA) Welding.....	38
3.2.4 Stick (MMA) Welding Fundamentals	39



EZIMIG215C

3.3 Installation & Operation for TIG Welding	41
3.3.1 Set up installation for TIG Welding	41
3.3.2 Operation of the TIG Lift welding method	42
3.3.3 DC TIG Welding	45
3.3.4 TIG Welding Fusion Technique	46
3.3.5 Tungsten Electrodes	48
3.3.6 Tungsten Preparation	50
3.3.7 Tig Gun switch control	52
3.4 Operation environment	53
3.5 Operation Notices	53
4 Welding trouble shooting	54
4.1 MIG weldi ng trouble shooting.....	54
4.2 MIG wire feed trouble shooting	56
4.3 DC TIG welding trouble shooting	57
4.4 MMA welding trouble shooting	60
5 Maintenance & Troubleshooting	62
5.1 Maintenance	62
5.2 Troubleshooting	63
5.3 List of error code	65
5.4 Electrical schematic drawing	66
Safety.....	67
Warranty	72



STRATA

SUPERIOR WELDING PRODUCTS



EZIMIG 215C

200A COMPACT INVERTER MIG / MMA WELDER

Ultra compact and easy to the EZIMIG 215C multi-process welder is a must have for todays industrial professionals. With the latest IGBT inverter technology, extreme stress testing to 440V and insulation class IP23, this machine is built to last.

- IGBT inverter technology for smooth & stable welding output and increased reliability
- Aluminium chassis
- Professional wire feeder provides a smooth, consistent wire feed
- MIG waveform (inductance) control of the arc for smooth welding results
- Industrial IP23 casing with front panel protection resists damage, moisture and corrosion
- Lightweight & compact design, ideal for portable applications
- MIG spot welding function with 2T/4T trigger control
- Accurate pre-setting and feedback of welding parameters & output with dual digital display meters
- Great control MIG welding with adjustable pre flow, post flow, burn back and soft start settings
- Intelligent protection system with temperature, voltage and current sensors for increased reliability and safety
- Designed to work with generator power supply with protection from power surges
- Reversible polarity for gas & gasless MIG welding
- Quick connect inlet gas fitting
- Accessories include 3m earth lead with heavy duty earth clamp, 4m MMA lead with heavy duty twist lock electrode holder, MT250-4E MIG torch, 2 stage flowmeter, argon gas regulator and adapter, 4m gas hose, gas inlet quick connector, hose clamps and MIG drive rollers.



DIMENSIONS (LxWxH)	WEIGHT	INPUT POWER SUPPLY	INPUT POWER SUPPLY TOLERANCE	MAXIMUM INPUT CURRENT	GENERATOR CAPACITY	MIG OUTPUT VOLTAGE	MIG OUTPUT CURRENT	MIG DUTY CYCLE	WIRE FEEDING SPEED	MMA CURRENT OUTPUT	MMA O/C VOLTAGE
550 x 215 x 415mm	20.5kg	230V AC 15A 50/60Hz	230±10%V	42A	10kVA	16 - 24V	40 - 200A	200A@25% 155A@60% 120A@100%	1.5 - 16.5 m/min	10 - 160A	63V

MMA DUTY CYCLE	INSULATION CLASS	POWER EFFICIENCY	POWER FACTOR	STANDARDS	MIG DRIVE ROLLERS AVAILABLE	MIG WIRE SPOOL SIZE	WELD THICKNESS	MMA ROD SIZE	WARRANTY
160A@15% 140A@60% 110A@100%	IP23	85%	0.65	EN60974-1: 2012	V Groove: 0.6 /0.8/0.9/1.0mm Knurled: 0.8/0.9/1.0mm U Groove: 0.8/1.0mm	D200mm/ D300mm 15KG	10mm Steel	1.6 -5.0mm	24 months







STRATA

SUPERIOR WELDING PRODUCTS



EZIMIG 215C MIG WELDING ACCESSORIES & CONSUMABLES

- Standard ● Optional
☆ Common Consumables

ACCESSORY:	EZIMIG 215C:
Arc Leads 	○ AAL3550
Earth Leads 	○ AEL3550
MIG Torch 	○ MT250-4E
Argon Regulator 	○ GR102ARFL
Gas Hose 	○ GH08
MIG Starter Kit	● MB25KIT
TIG Torch	● 17374
TIG Consumables Pack	● MPWKTIG-EU
Drive Roller 'V' Groove 0.6 - 0.8mm	○ 17835 (x 2)
Drive Roller 'V' Groove 0.9 - 1.0mm	○ 17836 (x 2)
Drive Roller 'V' Groove 1.0 - 1.2mm	● 17837 (x 2)
Drive Roller 'U' Groove 0.8 - 1.0mm	● 17841 (x 2)
Drive Roller 'U' Groove 1.0 - 1.2mm	-
Drive Roller 'U' Groove 1.2 - 1.6mm	● 17842 (x 2)
Drive Roller Knurled 0.8 - 0.9mm	○ 17838 (x 2)
Drive Roller Knurled 1.0 - 1.2mm	● 17839 (x 2)
Drive Roller Knurled 1.2 - 1.6mm	● 17840 (x 2)
MIG Tips (MMT) 0.6 - 1.6mm	☆ 0.6, 0.8, 0.9, 1.0, 1.2, 1.6mm
MIG Shrouds (MCN) 70 = Conical 71 = Cylindrical	☆ MTA2570 MTA2571
Tip Adaptors (MTA) 81 = M6 82 = M8	☆ MTA2581 MTA2582

Mild Steel MIG Wire - ER70S-6

- Copper coated MIG wire for general purpose welding of mild steel using CO₂ or argon based shielding gases.

CODE:	DESCRIPTION:
MW5KG06	5kg Spool - 0.6mm MIG wire (D200)
MW5KG08	5kg Spool - 0.8mm MIG wire (D200)
MW5KG09	5kg Spool - 0.9mm MIG wire (D200)
D300 MW15KG08S	15kg Spool - 0.8mm MIG wire (D300)
D300 MW15KG09S	15kg Spool - 0.9mm MIG wire (D300)
D300 MW15KG10	15kg Spool - 1.0mm MIG wire (D300)
D300 MW15KG12	15kg Spool - 1.2mm MIG wire (D300)



Welding Magnets

WT-WMG03	3" Welding Magnet
WT-WMG05	5" Welding Magnet



Chipping Hammer

- Heavy duty chipping hammer for the trade

WT-SPCH	Spring Handle Chipping Hammer
---------	-------------------------------



Industrial Storage Trolley

- Pull out drawer with storage, 25.85kg

32673	Integrated Trolley to suit Compact MIG Models
-------	---



Automatic Welding Helmets

- Variable Shade • Complete with batteries ready to go
- Suitable for automotive DIY and industrial use.

SV3000	Auto Welding Helmet, Shade 5 - 13 + Grind Function (MIG/TIG/MMA/Plasma)
SV4000	Auto Welding Helmet, Shade 4 - 13 + Grind Function (MIG/TIG/MMA/Plasma)
DW7000XL	Auto Welding Helmet, Shade 5 - 13 + PRSL Filtration System (MIG/TIG/MMA/Plasma)



SV3000



SV4000



DW7000XL comes with battery powered air respirator.



EZIMIG215C

EZIMIG215C Related Parts

Part number	Description
MIG Torch & Consumables	
MT250-4E	MB25 Mig Torch 4m (Euro)
MB25KIT	MIG Consumables Starter Kit - MB25
MCN2571	Nozzle cylindrical (2 pk)
MCN2570	Nozzle conical (2 pk)
MCN2572	Nozzle - Tapered (2 pk)
MMT2406	Mig tip 0.6mm (5 pk)
MMT2408	Mig tip 0.8mm/0.35 (5pk)
MMT2409	Mig tip 0.9mm/035 (55pk)
MMT2410	Contact Tip 1.0mm/040 (5 pk)
MMT2410AL	Contact Tip 1.0mm/040 ALI (5 pk)
MMT2412AL	Contact Tip 1.2mm/045 ALI (5pk)
MTA2481	Tip Adaptor
MSS2557	Shroud spring (2 pk)
Drive Rollers	
SW17835	0.6 /0.8mm V groove rollers x 2
SW17836	0.9 / 1.0mm V groove rollers x 2
SW17841	0.8 /1.0mm U groove rollers x 2
SW17842	1.2 / 1.6mm U groove rollers x 2
SW17833	Drive Roller 0.8/0.9mm knurled x 2
SW17839	Drive Roller 1.0/1.2mm flux cored x2
Liner	
MSL1549	Steel liner 0.6 - 0.9mm 4m
MSL2442	Steel liner 1.0 - 1.2mm x 4m
31535	Liner for Aluminium (please State the length needed)
TIG Torch	
17374	TIG Torch Pro-Grip 26 X 25Ft, Tgc End (Large Dinse) M12, <i>(needs correct plug to be fitted)</i>
Spool Gun	
18004	SP100N Spool Gun 8m, suits Strata AdvanceMIGModels <i>(needs correct plug to be fitted)</i>
MMA Consumables	
AAL3550	Arc Lead 25mm ² cable, 35-70mm plug, 4m 300A Twist-lock Electrode holder
AEL3550	Earth Lead 25mm ² cable, 35-70mm plug, 3m 300A Heavy duty earth clamp
Regulators	
GR101AR	Argon Twin Gauge Regulator
GADC02	C02 Cylinder to Argon Regulator Adaptor inc. nylon washer



1 Overview

1.1 Brief Introduction

MIG series of welding machines adopts the latest Pulse Width Modulation (PWM) technology and the Insulated Gate Bipolar Transistor (IGBT) power modules. It uses switching frequencies in the 20KHz-50KHz range so as to replace the traditional line-frequency transformer type welding machines. Thus, machines are characterized with excellent dynamic response, portability, small size, lightweight, low energy consumption, etc.

MIG series of welding machines uses Mix gases as shielding gas to realize gas shielded welding, active gas (Ar+O₂, Ar+CO₂ & CO₂) as shielded gas to realize MAG welding and inactive gas (Ar) as shielded gas to realize MIG welding.

MIG series of welding machines has built-in automatic protection functions to protect the machines from over-voltage, over-current and over-heat. If any one of the above problems happens, the LCD on the front panel will be display error code and output current will be shut off automatically for the machine to protect itself and prolong the equipment using life.

MIG series Features:

1. Digital control system, real-time display the welding parameters;
2. High performance multifunction power source (MIG/MAG);
3. Waveform control, stable welding arc;
4. IGBT technology, low power consumption;

MIG series of welding machine is suitable for all positions welding for various materials such as stainless steel, carbon steel, alloyed steel etc. Applications applied to pipe installment, petrochemical, architecture equipment, car repair, bicycle repair, handicraft and common steel fabrication.

MAG = Metal Active Gas Welding

MIG = Metal Inert Gas Welding

2 Operation

2.1 Machine Layout Description

Front and rear panel layout of welding machine

1. MIG torch euro connector.
2. Positive (+) welding power output connection socket.
3. MIG Torch Polarity Change Power Connection.
4. Remote connection plug.
5. TIG torch gas connector.
6. Negative (-) welding power output connection socket.
7. Gas inlet connector.
8. Power switch.
9. Input power cable.

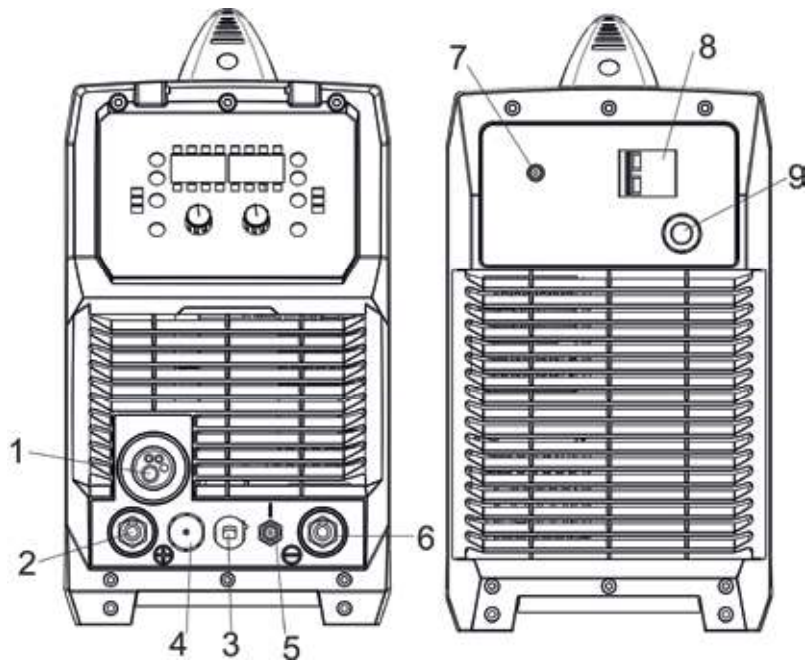

Wire Feeder of welding machine

10. Spool holder.
11. Wire feed tension adjustment (2x).
12. Wire feed tension arm (2x).
13. Wire feeder inlet guide.
14. Drive roller retainer (2x).
15. Wire drive roller (2x).
16. Wire feed motor.

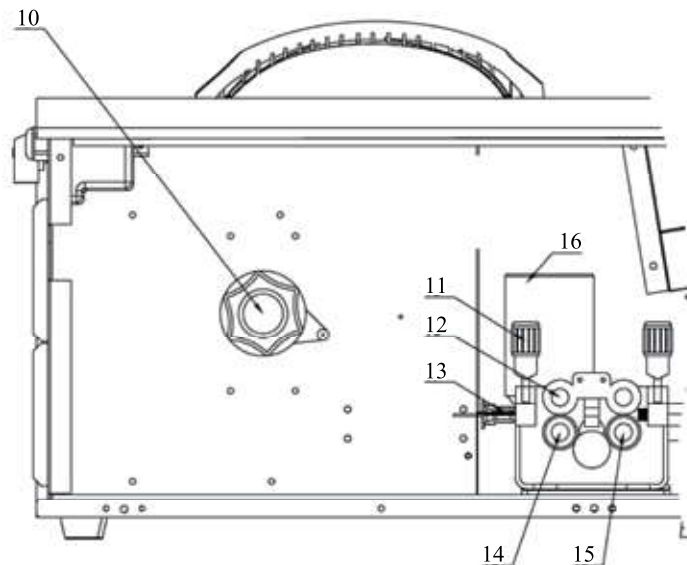

Control Panel of Welding Machine

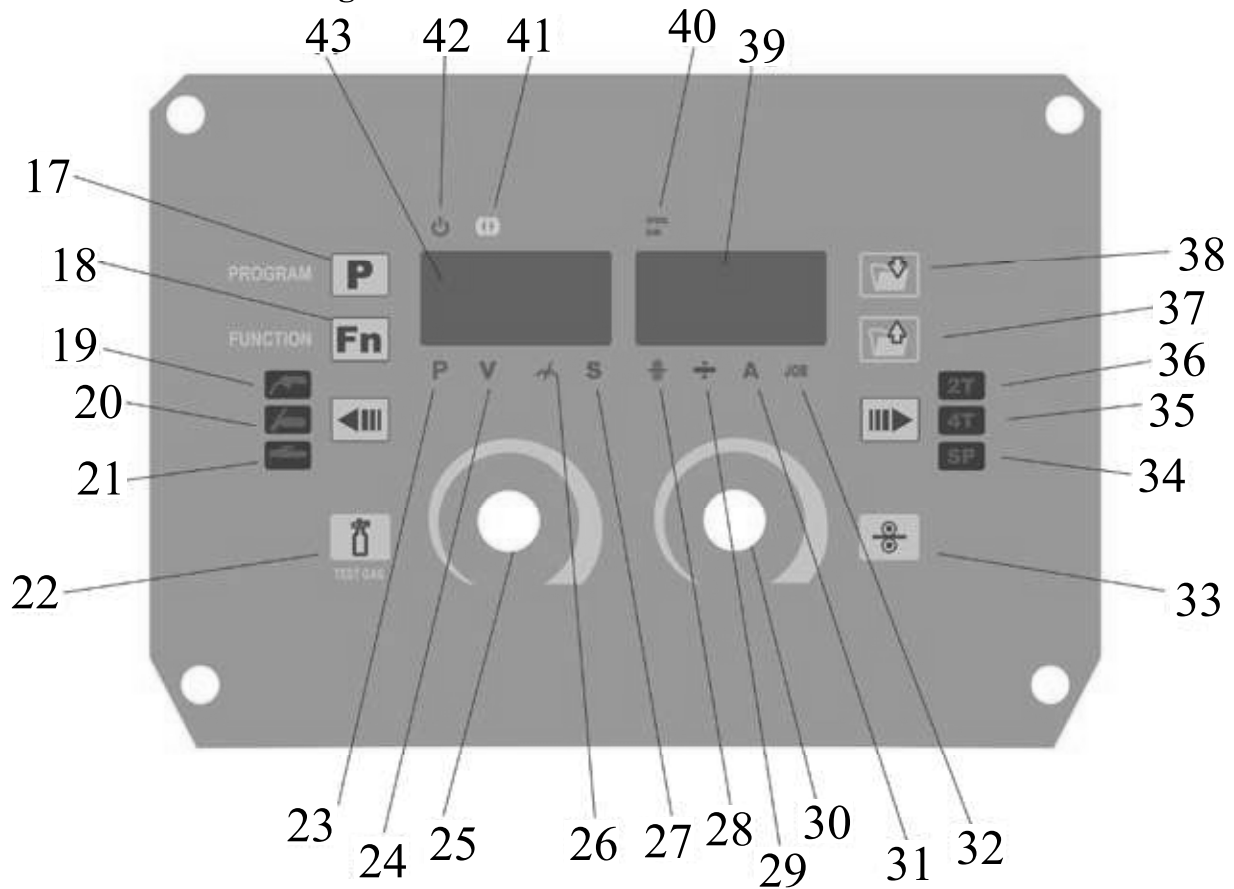

- | | |
|--|----------------------------------|
| 17. Program select | 31. Current indicator |
| 18. Function select | 32. Parameter indicator. |
| 19. MIG model | 33. Fast wire feeder |
| 20. TIG model | 34. Spot welding model |
| 21. MMA model | 35. 4T model |
| 22. Gas check | 36. 2T model |
| 23. Parameter Adjustment Indicator | 37. Job Recall |
| 24. Voltage Parameter Adjustment Indicator | 38. Job Storage |
| 25. Voltage adjust knob. | 39. Current display |
| 26. Wave Control Indicator | 40. Spool Gun Function Indicator |
| 27. Second Light Indicator | 41. Alarm indicator |
| 28. Wire feeder indicator. | 42. Power indicator |
| 29. Plate thickness select. | 43. Voltage indicator |
| 30. Current adjust knob | |



EZIMIG215C

2.2 Technical Data

Model	EZIMIG215C		
Parameters			
Input Voltage (V)	1~220/230/240V±10%		
Input Current (A)	MIG 43.7	TIG 31.6	MMA 45.4
Input Power (KW)	MIG 4.8	TIG 3.5	MMA 5.3
Welding Current (A)	40-200	10-200	10-200
No-load Voltage (V)	58		
Duty cycle (40%)	25% 200A	25% 200A	25% 200A
	60% 129A	60% 129A	60% 129A
	100% 100A	100% 100A	100% 100A
Diameter(mm)	Fe: 0.6/0.9/1.0 Ss: 0.8/0.9/ 1.0 Flux-Cored: 0.6/0.8/0.9/1.0		
Protection class	IP23		
Insulation class	H		
Dimensions (mm)	690X250X220		
Weight (Kg)	20KG		

Note: The above parameters are subject to change.

2.3 Duty cycle and Over-heat

The letter “X” stands for Duty Cycle, which is defined as the portion of the time a welding machine can weld continuously with its rated output current within a certain time cycle (10 minutes).

The relation between the duty cycle “X” and the output welding current “I” is shown as the right figure. If the welding machine is overheating, the IGBT

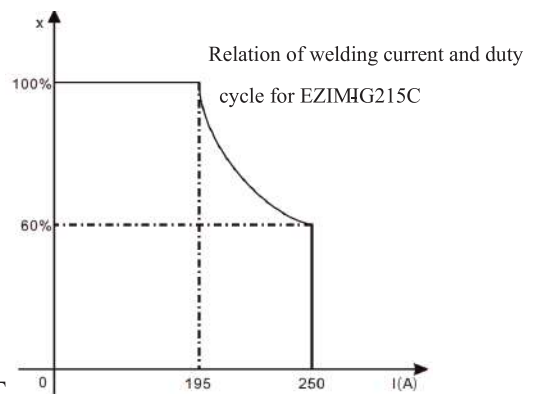

heat protection sensing will send a signal to the welding machine control unit to cut the over-output welding current OFF and light the over-heat pilot lamp on the front panel. In that case, the machine should not be welding for 10-15 minutes to cool down with the fanrunning. When operating the machine again, the welding output current or the duty cycle should be reduced.

2.4 Working Principle

The working principle of MIG series welding machine is shown as the following figure. Single-phase 110V/220V work frequency AC is rectified into DC, then is converted to medium frequency AC by inverter device (IGBT), after reducing voltage by medium transformer (the main transformer) and rectifying by medium frequency rectifier (fast recovery diodes), and is outputted by inductance filtering. The circuit adopts current feedback control technology to insure current output stably when MMA or TIG. And adopts voltage feedback control technology to insure voltage output stably when MIG. Meanwhile, the welding current parameter can be adjusted continuously and infinitely to meet with the requirements of welding craft.

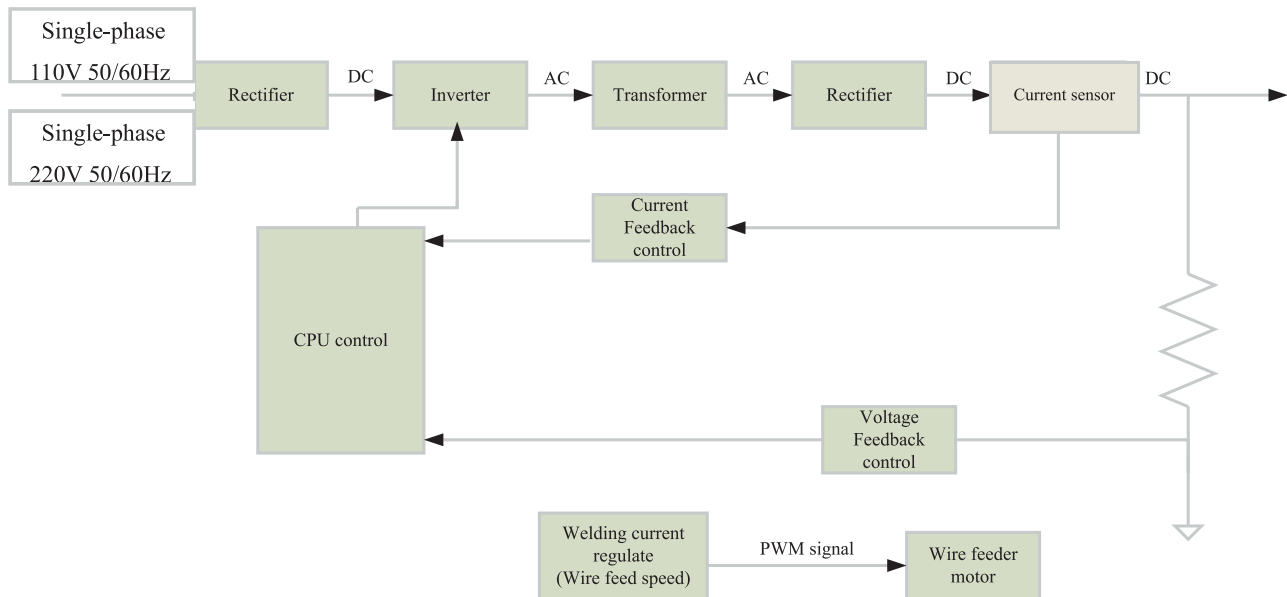

2.5 Volt-Ampere Characteristic

MIG series of welding machines has an excellent volt-ampere characteristic, whose graph is shown as the following figure. The relation between the rated loading voltage U_2 and welding current I_2 is as follows: $U_2=14+0.05I_2(V)$

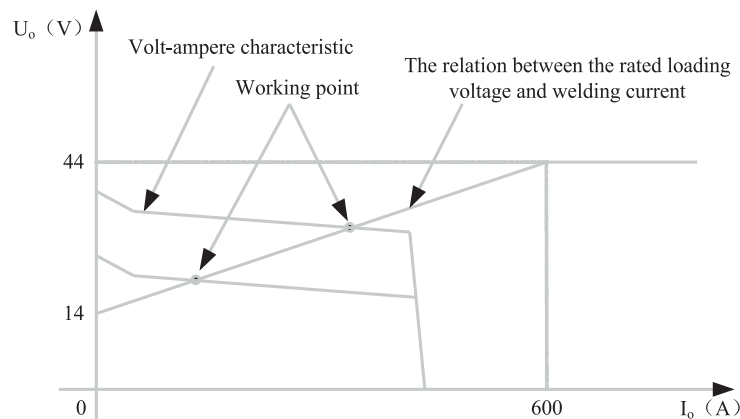



3 Installation & Operation

3.1 Installation & Operation for MIG Welding

3.1.1 Set up installation for MIG/MAG Welding

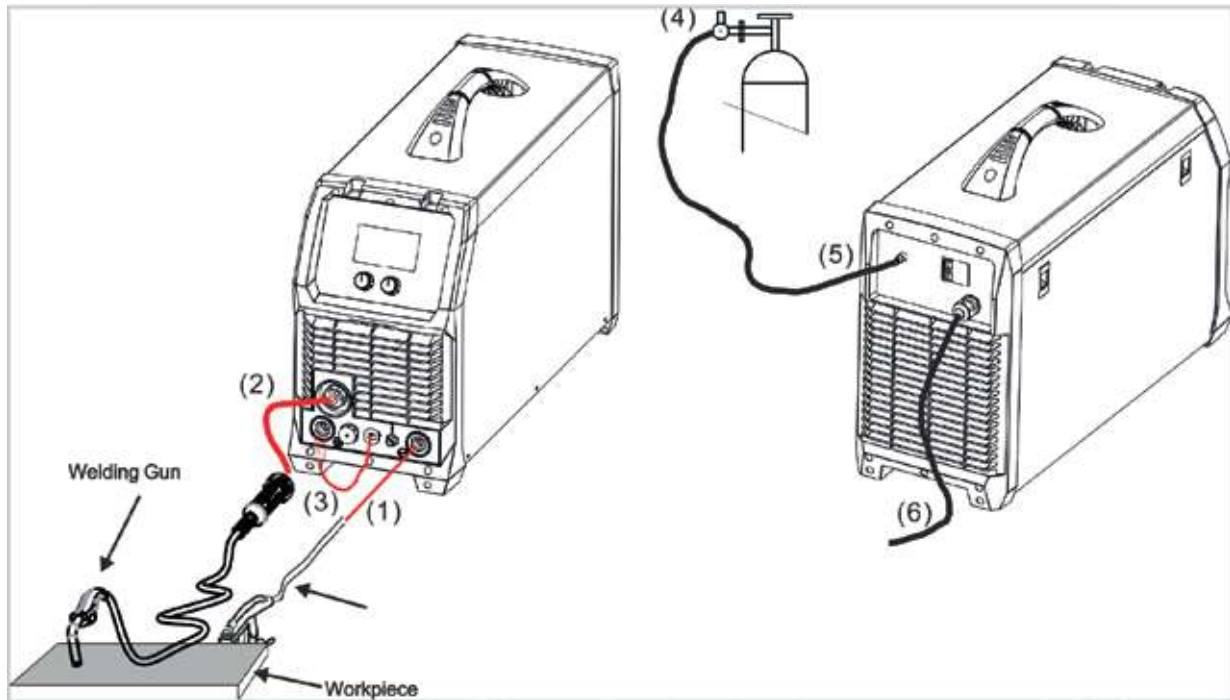

- (1) Insert the earth cable plug into the negative socket on the front of the machine and tighten it.
- (2) Plug the welding torch into the MIG torch connection socket on the front panel and tighten it.

IMPORTANT : When connecting the torch be sure to tighten the connection. A loose connection can result in the connector arcing and damaging the machine and gun connector.

- (3) Connect the MIG power connection lead to the positive welding power output socket.

Note if this connection is not made, there will be no electrical connection to the welding torch!

- (4) Connect the gas regulator to the Gas Cylinder and connect the gas line to the Gas Regulator.

Check for Leaks!

- (5) Connect the gas line to gas connector on the rear panel. **Check for Leaks!**
- (6) Connect the power cable of welding machine with the output switch in electric box on site.



EZIMIG215C

(7) Place the Wire Spool onto the Spool Holder. Snip the wire from the spool being sure to hold the wire to prevent rapid uncoiling. Feed the wire into the wire feeder inlet guide tube through to the drive roller.



(8) Carefully feed the wire over the drive roller into the outlet guide tube, feed through about 150mm into the torch receptacle. Check that the drive roller size is compatible with the wire diameter, replace the roller if necessary.

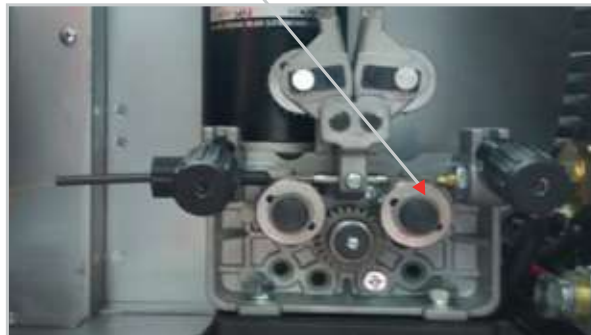

(9) Align the wire into the groove of the drive roller and close down the top roller making sure the wire is in the groove of the bottom drive roller, lock the pressure arm into place. Apply a medium amount of pressure to the drive roller.

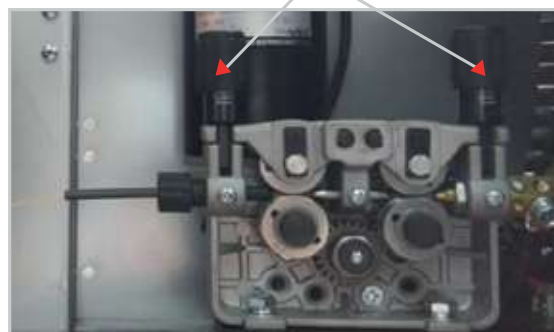

(10) Remove the gas nozzle and contact tip from the torch neck.





EZIMIG215C

- (11) Pull the trigger to feed the wire through to the torch neck, release the trigger when the wire exits the torch neck.



- (12) Fit the correct sized contact tip and feed the wire through it, screw the contact tip into the tip holder of the torch head and nip it up tightly.

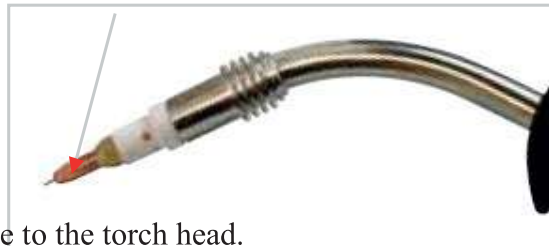

- (13) Fit the gas nozzle to the torch head.



- (14) Carefully open the gas cylinder valve and set the required gas flow rate.

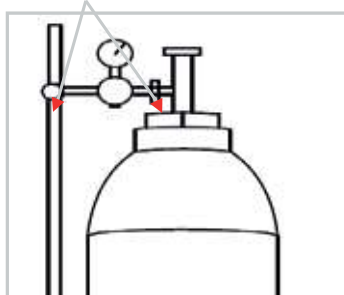



3.1.2 Wire Feed Roller Selection

The importance of smooth consistent wire feeding during MIG welding cannot be emphasized enough. Simply put the smoother the wire feed then the better the welding will be.

Feed rollers or drive rollers are used to feed the wire mechanically along the length of the welding gun. Feed rollers are designed to be used for certain types of welding wire and they have different types of grooves machined in them to accommodate the different types of wire. The wire is held in the groove by the top roller of the wire drive unit and is referred to as the pressure roller, pressure is applied by a tension arm that can be adjusted to increase or decrease the pressure as required. The type of wire will determine how much pressure can be applied and what type of drive roller is best suited to obtain optimum wire feed.

Solid Hard Wire - like Steel, Stainless Steel require a drive roller with a V shape groove for optimum grip and drive capability. Solid wires can have more tension applied to the wire from the top pressure roller that holds the wire in the groove and the V shape groove is more suited for this. Solid wires are more forgiving to feed due to their higher cross sectional column strength, they are stiffer and don't bend so easy.

Soft Wire - like Aluminium requires a U shape groove. Aluminium wire has a lot less column strength, can bend easily and is therefore more difficult to feed. Soft wires can easily buckle at the wire feeder where the wire is fed into inlet guide tube of the torch. The U-shaped roller offers more surface area grip and traction to help feed the softer wire. Softer wires also require less tension from the top pressure roller to avoid deforming the shape of the wire, too much tension will push the wire out of shape and cause it to catch in the contact tip.



Flux Core / Gasless Wire - these wires are made up of a thin metal sheath that has fluxig and metal compounds layered onto it and then rolled into a cylinder to form the finished wire. The wire cannot take too much pressure from the top roller as it can be crushed and deformed if too much pressure is applied. A knurled drive roller has been developed and it has small serrations in the groove, the serrations grip the wire and assist to drive it without too much pressure from the top roller. The down side to the knurled wire feed roller on flux cored wire is it will slowly over time bit by bit eat away at the surface of the welding wire, and these small pieces will eventually go down into the liner. This will cause clogging in the liner and added friction that will lead to welding wire feed problems. A U groove wire can also be used for flux core wire without the wire particles coming of the wire surface. However it is considered that the knurled roller will give a more positive feed of flux core wire without any deformation of the wire shape.

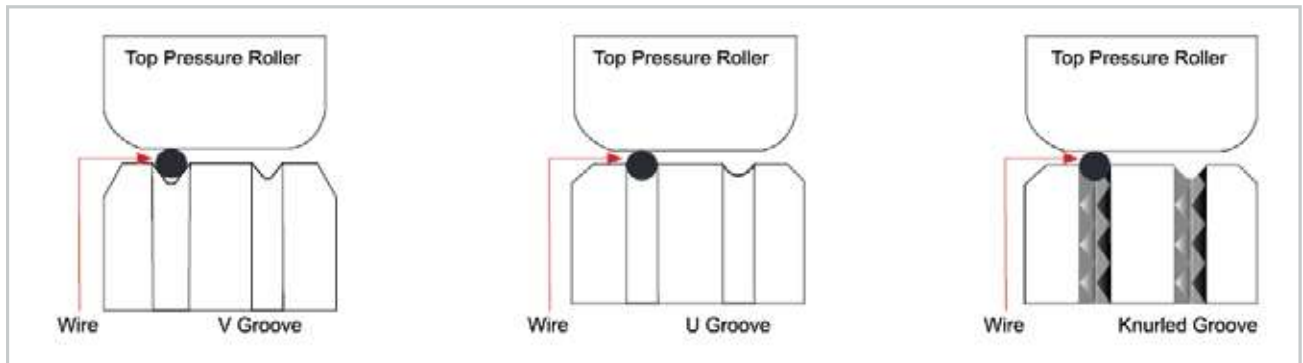

3.1.3 Wire Installation and Set Up Guide

Again the importance of smooth consistent wire feeding during MIG welding cannot be emphasized enough. The correct installation of the wire spool and the wire into the wire feed unit is critical to achieving an even and consistent wire feed. A high percentage of faults with mig welders emanate from poor set up of the wire into the wire feeder. The guide below will assist in the correct setup of your wire feeder.



(1) Remove the spool retaining nut.



(2) Note the tension spring adjuster and spool locating pin.

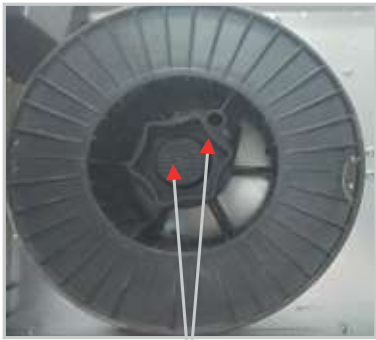

(3) Fit the wire spool onto the spool holder fitting the locating pin into the location hole on the spool. Replace the spool retaining nut tightly.



(4) Snip the wire carefully, be sure to hold the wire to prevent the spool uncoiling. Carefully feed the wire into the inlet guide tube of the wire feed unit.

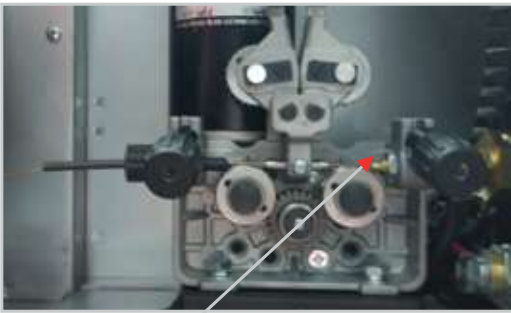

(5) Feed the wire through the drive roller and into the outlet guide tube of the wire feeder.

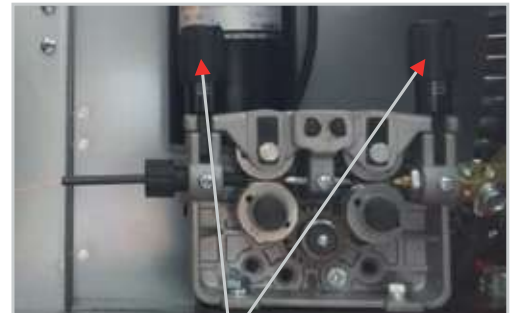

(6) Lock down the top pressure roller and apply a medium amount of pressure using the tension adjustment knob.

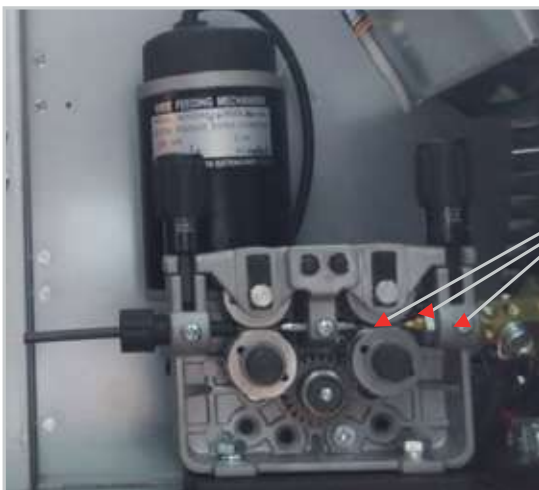

(7) Check that the wire passes through the centre of the outlet guide tube without touching the sides. Loosen the locking screw and then loosen the outlet guide tube retaining nut too make adjustment if required. Carefully retighten the locking nut and screw to hold the new position.



EZIMIG215C



(8) A simple check for the correct drive tension is to bend the end of the wire over hold it about 100mm from your hand and let it run into your hand, it should coil round in your hand without stopping and slipping at the drive rollers, increase the tension if it slips.

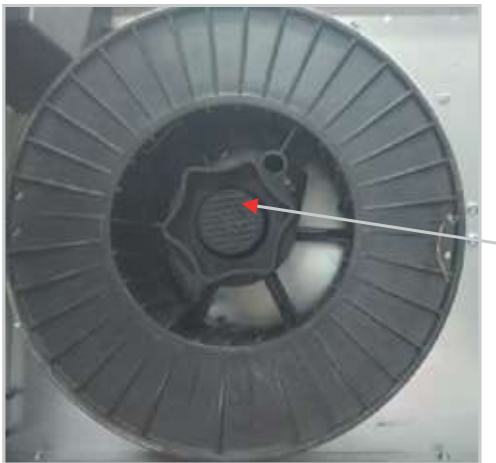

(9) The weight and speed of the wire spool turning creates an inertia that can cause the spool to run on and the wire loop over the side of the spool and tangle. if this happens increase the pressure on the tension spring inside the spool holder assembly using the tension adjustment screw.

3.1.4 MIG Torch Liner Installation

- (1) Lay the torch out straight on the ground and remove the front end parts.



- (2) Remove the liner retaining nut.

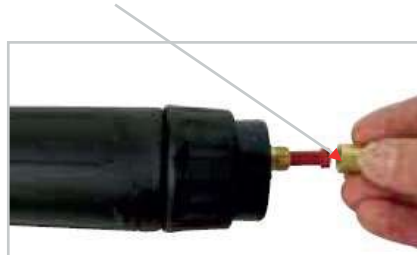

- (3) Carefully pull the liner out of the torch cable assembly.



- (4) Select the correct new liner and carefully unravel avoiding putting any kinks in the liner, if you kink the liner it will make it no good and will require replacement.



- (5) Carefully and slowly feed the liner in short forward movements down the cable assembly all the way through and out the torch neck end. Avoid kinking the liner, kinking liner it will make it no good and require replacement.

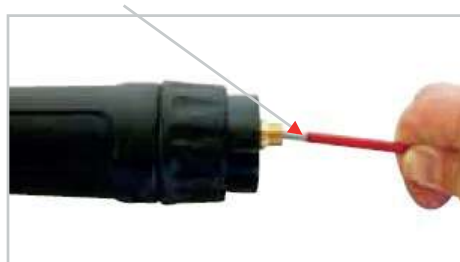



EZIMIG215C

- (6) Fit the liner retaining nut and screw down only 1/2 way .

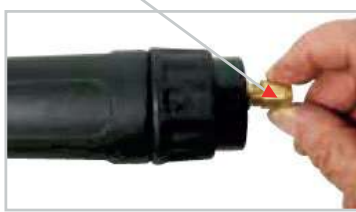

- (7) Leaving the torch straight snip the liner approximately 3mm past the end of the torch neck .



- (8) Place the tip holder over the end of the liner and screw into the torch neck nipping it up tight.



- (9) Screw down the liner nut the remaining 1/2 and nip it up tight. This method compresses the liner inside the torch cable assembly preventing it moving during use and ensures good wire feed.



3.1.5 MIG Torch Liner Types and Information

MIG Torch Liners

The liner is both one of the simplest and most important components of a MIG gun. Its sole purpose is to guide the welding wire from the wire feeder, through the gun cable and up to the contact tip.

Steel Liners

Most MIG gun liners are made from coiled steel wire also known as piano wire, which provides the liner with good rigidity and flexibility and allows it to guide the welding wire smoothly through the welding cable as it bends and flex during operational use. Steel liners are primarily



EZIMIG215C

used for feeding of solid steel wires, other wires such as Aluminium, Silicon Bronze etc will perform better using a teflon or Polyamide line. The internal diameter of the liner is important and relative to the wire diameter being used and will assist in smooth feeding and prevention of the wire kinking and birdnesting at the drive rollers. Also bending the cable too tightly during welding increases the friction between the liner and the welding wire making it more difficult to push the wire through the liner resulting in poor wire feeding, pre-mature liner wear and birdnesting. Dust, grime and metal particles can accumulate inside the liner over time and cause friction and blockages, it is recommended to periodically blow out the liner with compressed air. Small diameter welding wires, 0.6mm through 1.0mm have relatively low columnar strength, and if matched with an oversized liner, can cause the wire to wander or drift within the liner. This in turn leads to poor wire feeding and premature liner failure due to excessive wear. By contrast, larger diameter welding wires, 1.2mm through 2.4mm have much higher columnar strength but it is important to make sure the liner has enough internal diameter clearance. Most manufacturers will produce liners sized to match wire diameters and length of welding torch cable and most are colour coded to suit.

Steel Liners



Teflon and Polyamide (PA) Liners

Teflon liners are well suited for feeding soft wires with poor column strength like aluminium wires. The interiors of these liners are smooth and provide stable feedability, especially on small diameter welding wire. Teflon can be good for higher heat applications that utilize water-cooled torches and brass neck liners. Teflon has good abrasion resistance characteristics and can be used with a variety of wire types such as silicon bronze, stainless steel as well as aluminium. A note of caution to carefully inspect the end of the welding wire prior to feeding it down the liner. Sharp edges and burrs can score the inside of the liner and lead to blockages and accelerated wear. Polyamide Liners (PA) are made of carbon infused nylon and are ideal for softer aluminium, copper alloy welding wires and push pull torch applications. These liners are generally fitted with a floating collet to allow the liner to be inserted all the way to the feed rollers.



EZIMIG215C

Blue-0.6mm-0.8mm

Red - 0.9mm - 1.2mm

Yellow - 1.6mm

Black-1.0mm-1.6mm

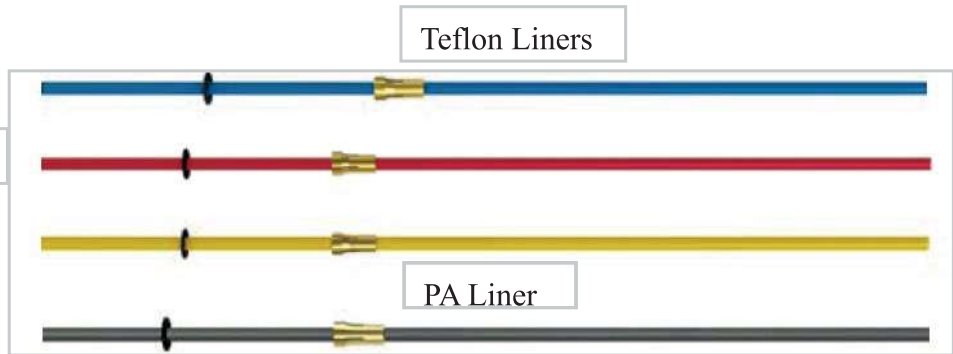

Copper - Brass Neck Liners

For high heat applications fitting brass or copper wound jumper or neck liner on the end of the liner at the neck end will increase the working temperature of the liner as well as improve the electrical conductivity of the welding power transfer to the wire.

Neck Liner

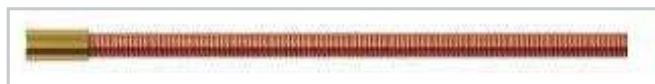

3.1.6 Torch & Wire Feed Set Up for Aluminium Wire

- (1) Lay the torch out straight on the ground and remove the front end parts



- (2) Remove the liner retaining nut.



- (3) Carefully pull the liner out of the torch cable assembly.



(4) Select a PA or liner and carefully unravel avoiding putting any kinks in the liner.



(5) Carefully and slowly feed the liner in short forward movements down the cable assembly all the way through and out the torch neck end. Avoid kinking the liner, kinking the liner will ruin it and require replacement.



(6) Fit the liner collet, liner O-ring and liner retaining nut.



(6) Push the liner firmly into the torch lead and tighten the liner retaining nut

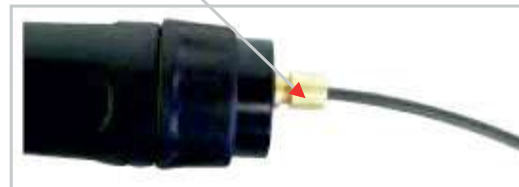

(7) Leave the liner extending out the end of the torch neck end by 3mm.



(8) Place the tip holder over the end of the liner and screw into the torch neck nipping it up tight.





EZIMIG215C

- (9) Connect the torch to the machine tighten and secure the torch euro connector to the machine euro connection.
- (10) Install a U groove drive roller of the correct size to match the wire diameter being used.

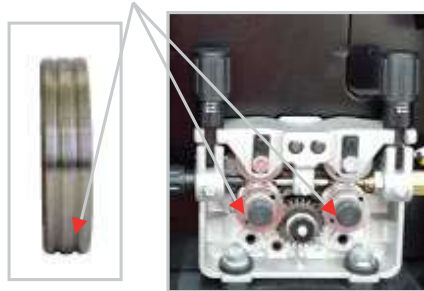

- (11) Place aluminium wire onto spool holder. Feed the wire through the inlet guide tube on to the drive roller.

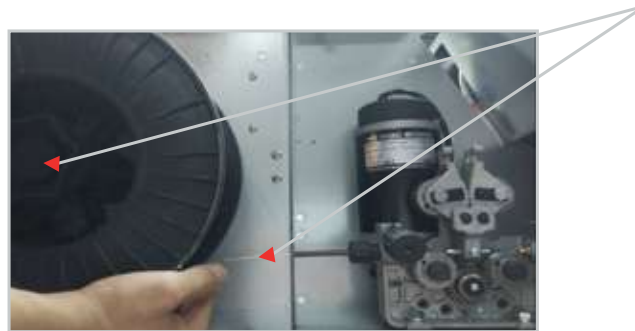

3.1.7 Set up installation for Spool Gun

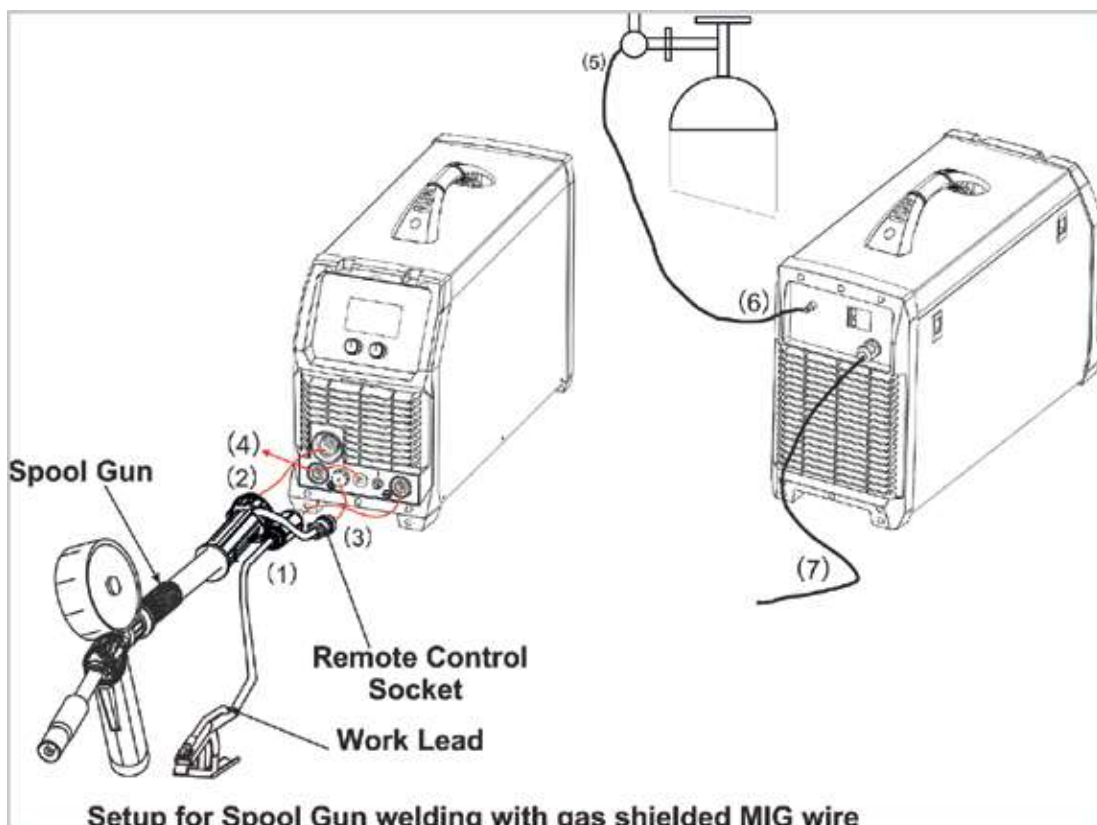



EZIMIG215C

- (1) Insert the earth cable plug into the Negative socket on the front of the machine and tighten it.
- (2) Connect the Spool Gun to the Mig torch connection socket on the front panel and tighten it.

IMPORTANT : When connecting the torch be sure to tighten the connection. A loose connection can result in the connector arcing and damaging the machine and gun connector.

- (3) Connect the Spool Gun control cable to the multipin receptacle on the front panel .
- (4) Connect the MIG power connection lead to the positive welding power output socket.
- (5) Connect the gas regulator to the Gas Cylinder and connect the gas line to the Gas Regulator.

Check for Leaks!

- (6) Connect the gas line to gas connector on the rear panel. **Check for Leaks!**
- (7) Connect the power cable of welding machine with the output switch in electric box on site.
- (8) Spool Gun Switch turn on (up).
- (9) Take the Spool Gun and remove the spool cover .

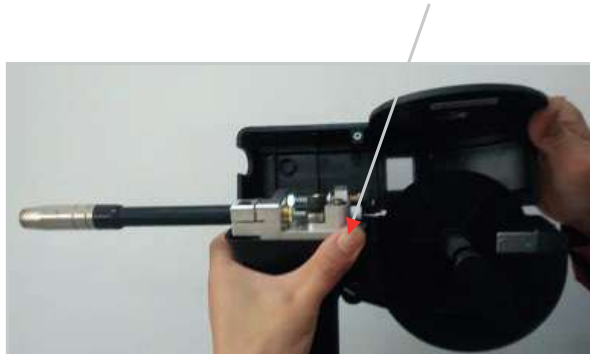



EZIMIG215C

- (10) Place the Wire Spool onto the Spool Holder - Hold and snip the wire from the spool being sure to hold the wire to prevent rapid uncoiling.

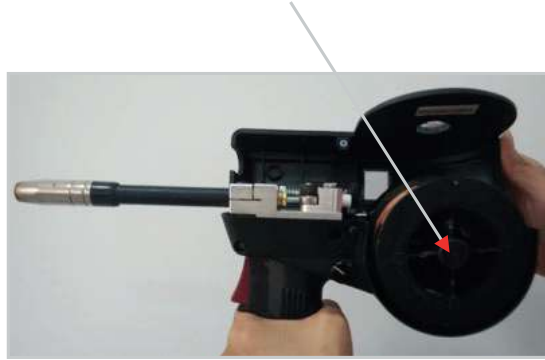

- (11) Carefully feed the wire through the drive roller into the inlet guide tube. Swing back and clip down the wire tension swing arm.

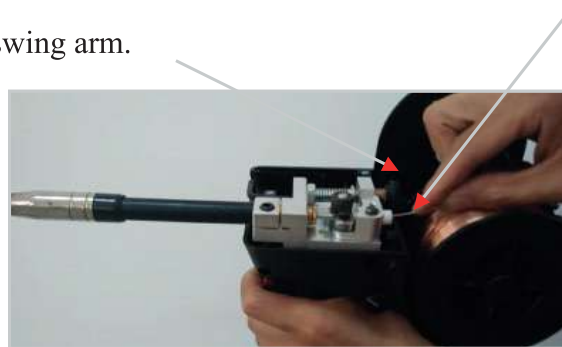

- (12) Pull the trigger to drive the wire through the neck until it exits the contact tip holder



- (13) Close the wire feed housing cover, ready for welding.
(14) Carefully open the gas cylinder valve and set the required gas flow rate.
(15) Set the welding parameters (refer to §4.1.3).



EZIMIG215C

3.1.8 MIG Torch /Spool Gun control

Parts Diagram for the MIG GUN

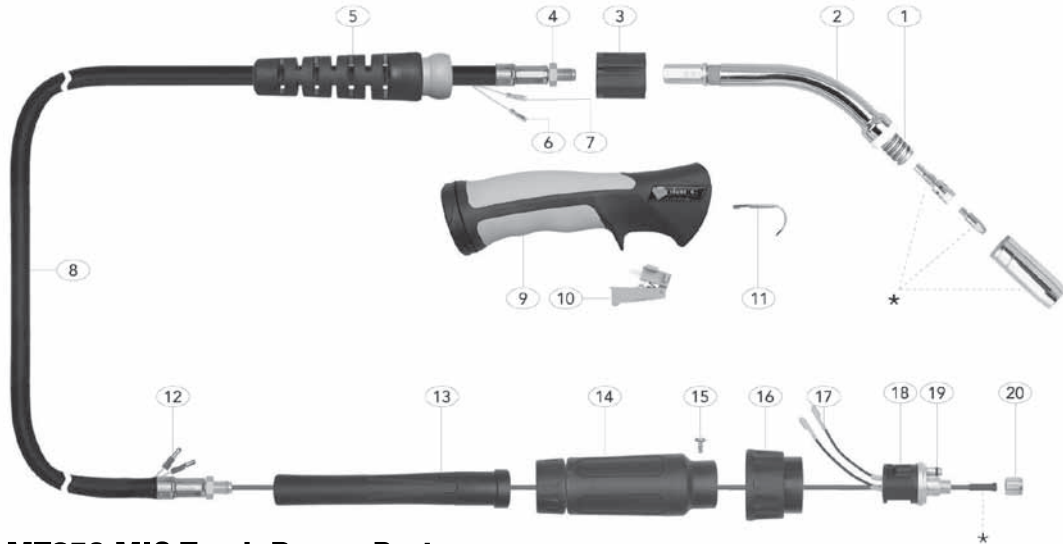

Binzel MT250 MIG Torch Range Parts

1.	MSS2557	Shroud Spring
2.	MSN2554	Swan Neck Assembly
5.	UG8015	Handle Cable Support C/W Ball Joint
9.	B2514	Ergo Handle Kit C/W Lock Nut
10.	UG2516	Medium / Large Ergo Trigger
19.	MOR1596	Gun Plug 'O' Ring
20.	MLN1597	Liner Nut

All products conform to EN60974-7 and are RoHS, REACH and WEEE compliant

The operation for the MIG GUN

1. Service the wire feed mechanism at least every time the reel is changed.

- Check the wear of the feed roll groove and change the feed roll when necessary.
- Clean the welding gun wire guide with compressed air.

2. Cleaning the wire guide

Pressure of the feed rolls remove metal dust from the filler wire's surface which then finds its way to the wire guide. If the wire guide is not cleaned, it gradually clogs up and causes wire feed malfunctions. Clean the wire guide in the following manner:

- Remove the welding gun's gas nozzle, contact tip and contact tip's adapter.
- With a pneumatic pistol, blow compressed air through the wire guide.
- Blow the wire feed mechanism and reel housing clean with compressed air.
- Reattach the welding gun's parts. Tighten the contact tip and contact tip's adapter to spanner tightness.



EZIMIG215C

3. Changing the wire guide

If the wire guide is too worn or totally clogged, change it to a new one according to the following instructions.

- Open the mounting nut of the wire guide which exposes the end of the wire guide.
- Straighten the welding gun's cable and withdraw the wire guide from the gun.
- Push a new wire guide in to the gun. Make sure that the wire guide enters all the way into the contact tip's adapter and that there is an O-ring at the machine-end of the guide.
- Tighten the wire guide in place with the mounting nut.
- Cut the wire guide 2mm from the mounting nut and file the sharp edges of the cut round.
- Reattach the gun in place and tighten the parts to spanner tightness.

Spool Gun



Gun switch

Spool cover switch

Adjust current button

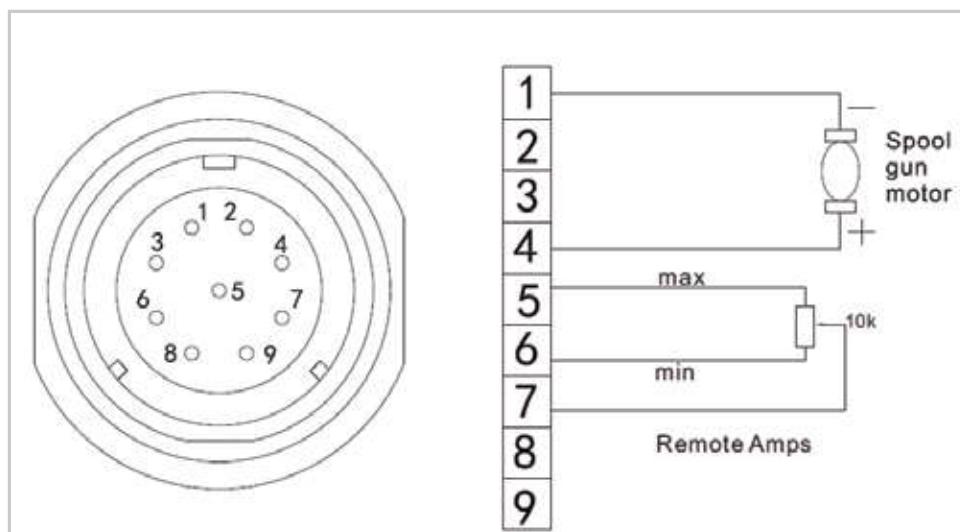



EZIMIG215C

Remote Control Socket

Socket Pin	Function
1	Spool gun motor
2	Not connected
3	Not connected
4	Spool gun motor
5	10k ohm (maximum) connection to 10k ohm remote control potentiometer.
6	Zero ohm (minimum) connection to 10k ohm remote control potentiometer.
7	Wiper arm connection to 10k ohm remote control potentiometer.
8	Not connected
9	Not connected

3.1.9 MIG Welding

Definition of MIG Welding

MIG (metal inert gas) welding also known as GMAW (gas metal arc welding) or MAG (metal active gas welding), is a semi-automatic or automatic arc welding process in which a continuous and consumable wire electrode and a shielding gas are fed through a welding gun. A constant voltage, direct current power source is most commonly used with MIG welding. There are four primary methods of metal transfer in MIG welding, called short circuit (also known as dip transfer) globular transfer, spray transfer and pulsed-spray, each of which has distinct properties and corresponding advantages and limitations. To perform MIG welding, the basic necessary equipment is a welding gun, a wire feed unit, a welding power supply, an electrode wire, and a shielding gas supply. Short circuit transfer is the most common used method whereby the wire electrode is fed continuously down the welding torch through to and exiting the contact tip. The wire touches the work piece and causes a short circuit the wire heats up and begins to form a molten bead, the bead separates from the end of the wire and forms a droplet that is transferred into the weld pool. This process is repeated about 100 times per second, making the arc appear constant to the human eye.

Principles of welding

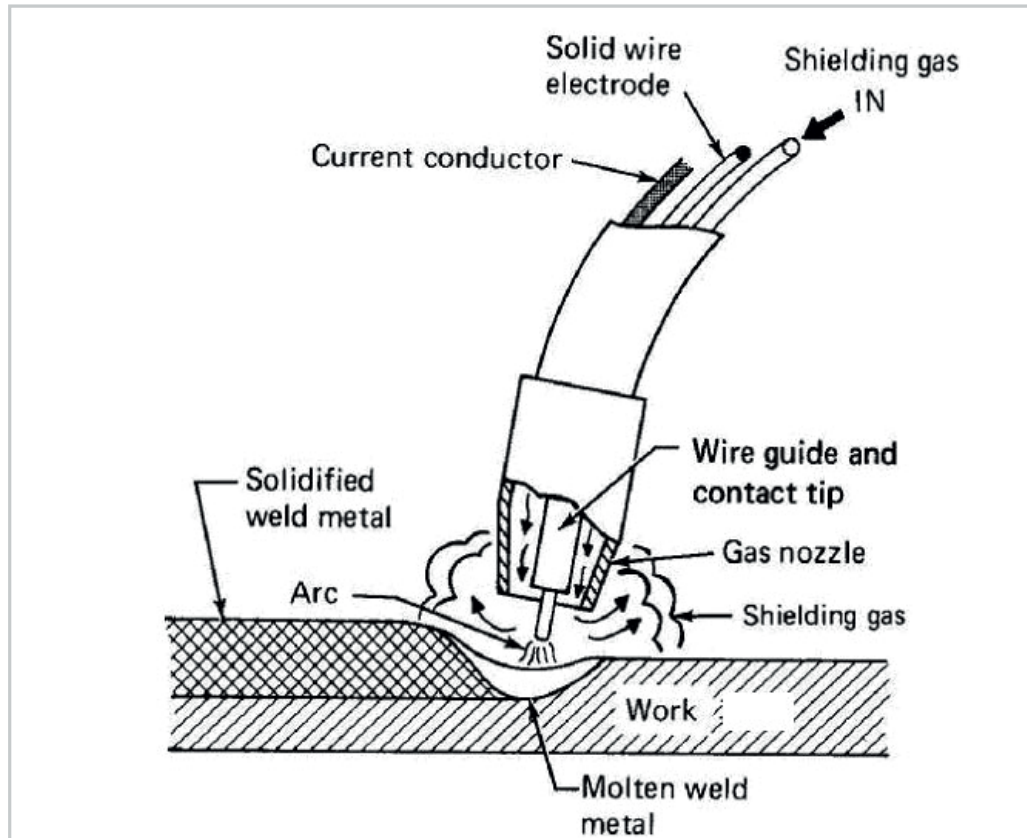

Short Circuit Transfer - Short circuit transfer is the most common used method whereby the wire electrode is fed continuously down the welding torch through to and exiting the contact tip. The wire touches the work piece and causes a short circuit the wire heats up and begins to form a molten bead, the bead separates from the end of the wire and forms a droplet that is transferred into the weld pool. This process is repeated about 100 times per second, making the arc appear constant to the human eye.



EZIMIG215C

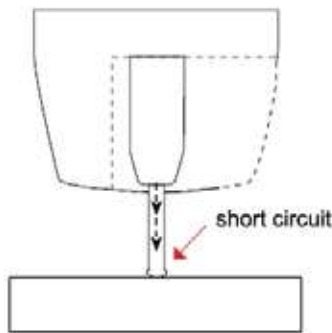

The wire approaches the work piece and touches the work creating a short circuit between the wire and the base metal, because there is no space between the wire and the base metal there is no arc and current flows through the wire.

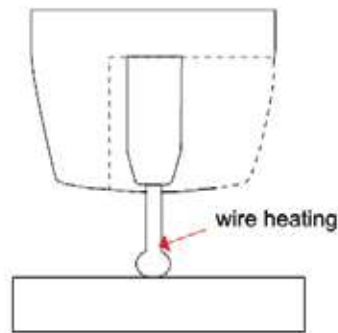

The wire cannot support all the current flow, resistance builds up and the wire becomes hot and weak and begins to melt.

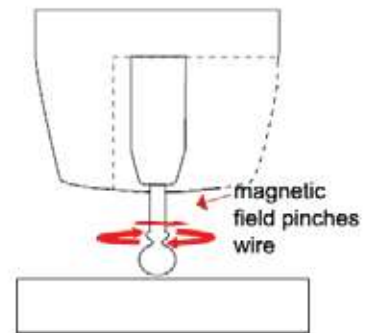

The current flow creates a magnetic field that begins to pinch the melting wire forming it into droplet.

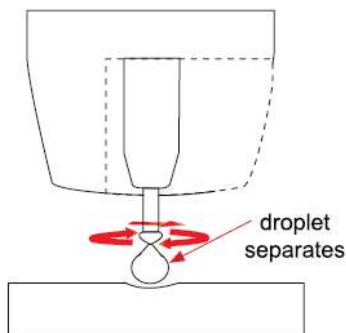

The pinch causes the forming droplet to separate and fall towards the now creating weld pool.

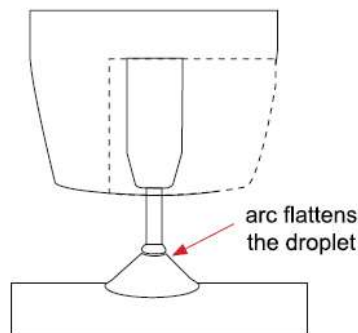

An arc is created at the separation of the droplet and the heat and force of the arc flattens out the droplet into the weld pool. The heat of the arc melts the end of the wire slightly as it feeds towards the base metal.

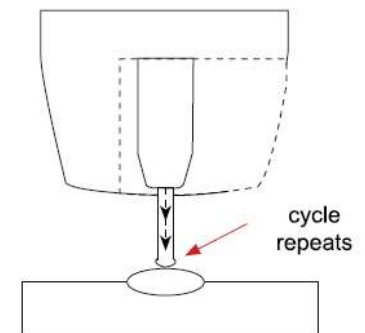

The wire feed speed overcomes the heat of the arc and the wire again approaches the work to short circuit and repeat the cycle.

Basic MIG Welding

Good weld quality and weld profile depends on gun angle, direction of travel, electrode extension (stick out), travel speed, thickness of base metal, wire feed speed and arc voltage. To follow are some basic guides to assist with your setup.

Gun Position - Travel Direction, Work Angle: Gun position or technique usually refers to how the wire is directed at the base metal, the angle and travel direction chosen. Travel speed and work



EZIMIG215C

angle will determine the characteristic of the weld bead profile and degree of weld penetration

Push Technique - The wire is located at the leading edge of the weld pool and pushed towards the un-melted work surface. This technique offers a better view of the weld joint and direction of the wire into the weld joint. Push technique directs the heat away from the weld puddle allowing faster travel speeds providing a flatter weld profile with light penetration - useful for welding thin materials. The welds are wider and flatter allowing for minimal clean up / grinding time.

Perpendicular Technique - The wire is fed directly into the weld, this technique is used primarily for automated situations or when conditions make it necessary. The weld profile is generally higher and a deeper penetration is achieved.

Drag Technique - The gun and wire is dragged away from the weld bead. The arc and heat is concentrated on the weld pool, the base metal receives more heat, deeper melting, more penetration and the weld profile is higher with more build up.

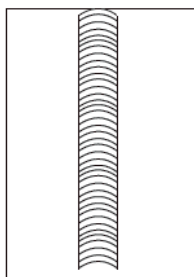
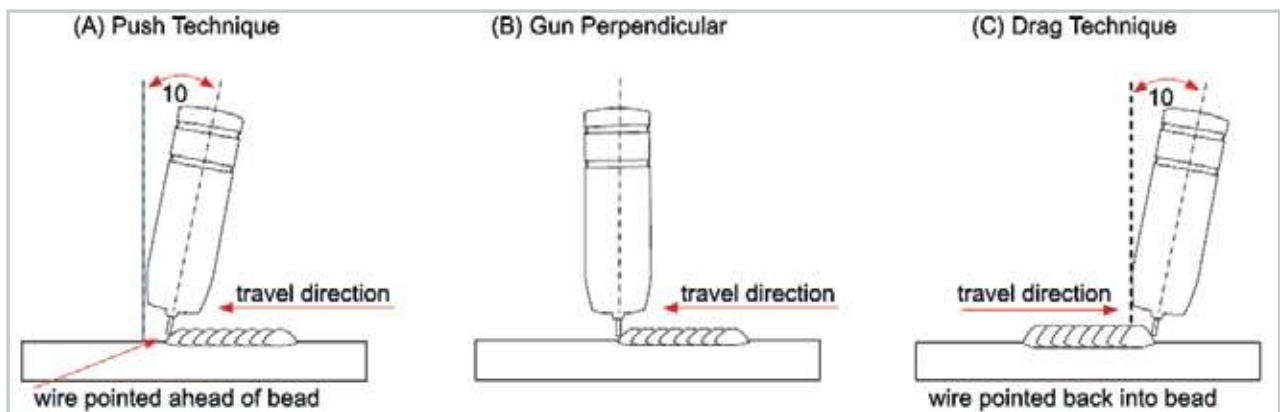

flat even weld profile
light penetration

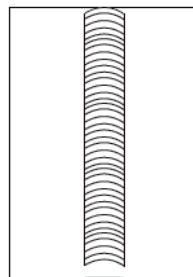

narrower weld profile
even penetration

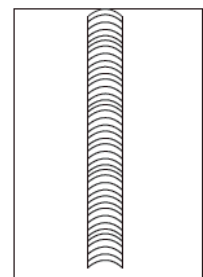

narrow higher
weld profile more
penetration

Travel Angle - Travel angle is the right to left angle relative to the direction of welding. A travel angle of 5°- 15° is ideal and produces a good level of control over the weld pool. A travel angle greater than 20° will give an unstable arc condition with poor weld metal transfer, less penetration, high levels of spatter, poor gas shield and poor quality finished weld.

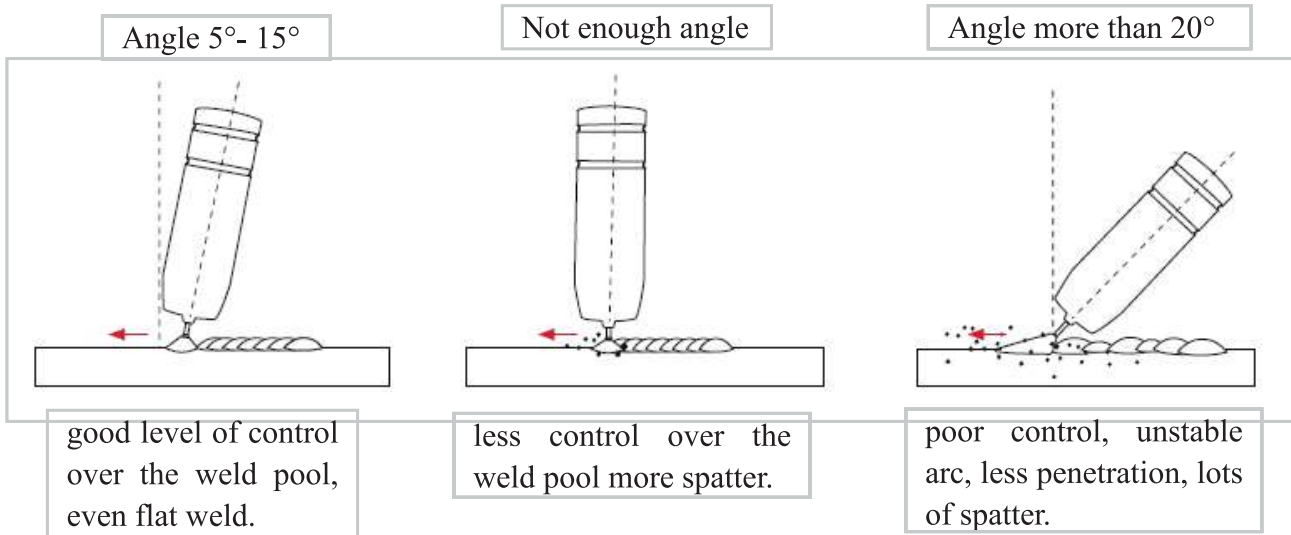

Angle to Work - The work angle is the forward back angle of the gun relative to the work piece. The correct work angle provides good bead shape, prevents undercut, uneven penetration, poor gas shield and poor quality finished weld.

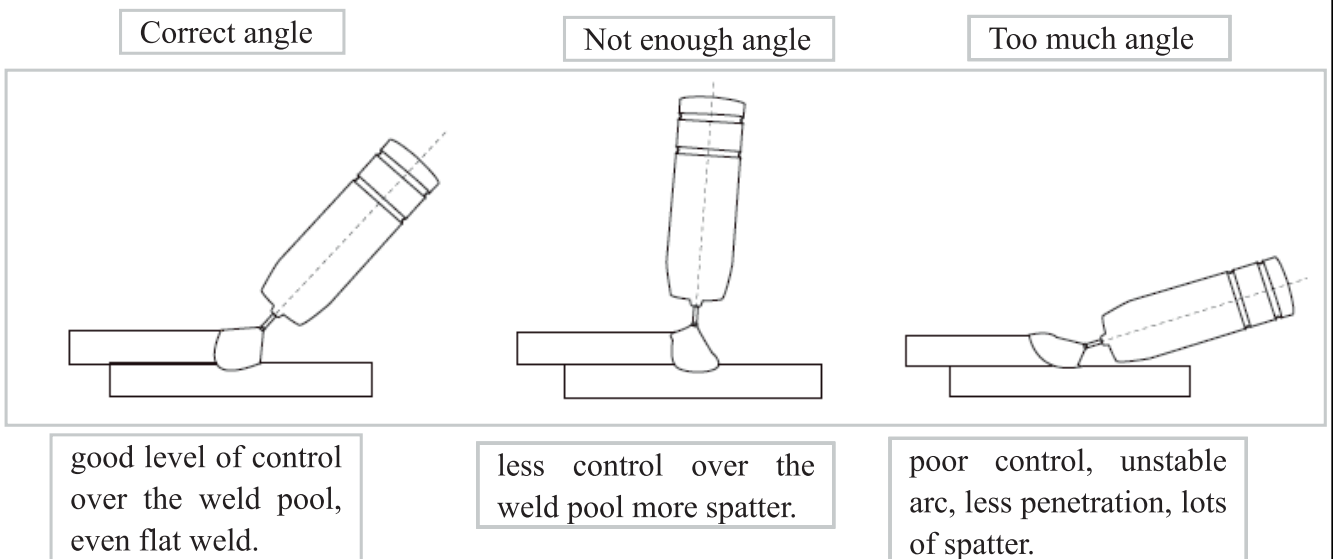

Stick Out- Stick out is the length of the unmelted wire protruding from the end of the contact tip. A constant even stick out of 5-10mm will produce a stable arc, and an even current flow providing good penetration and even fusion. Too short stick out will cause an unstable weld pool, produce



EZIMIG215C

spatter and over heat the contact tip. Too long stick out will cause an unstable arc, lack of penetration, lack of fusion and increase spatter.

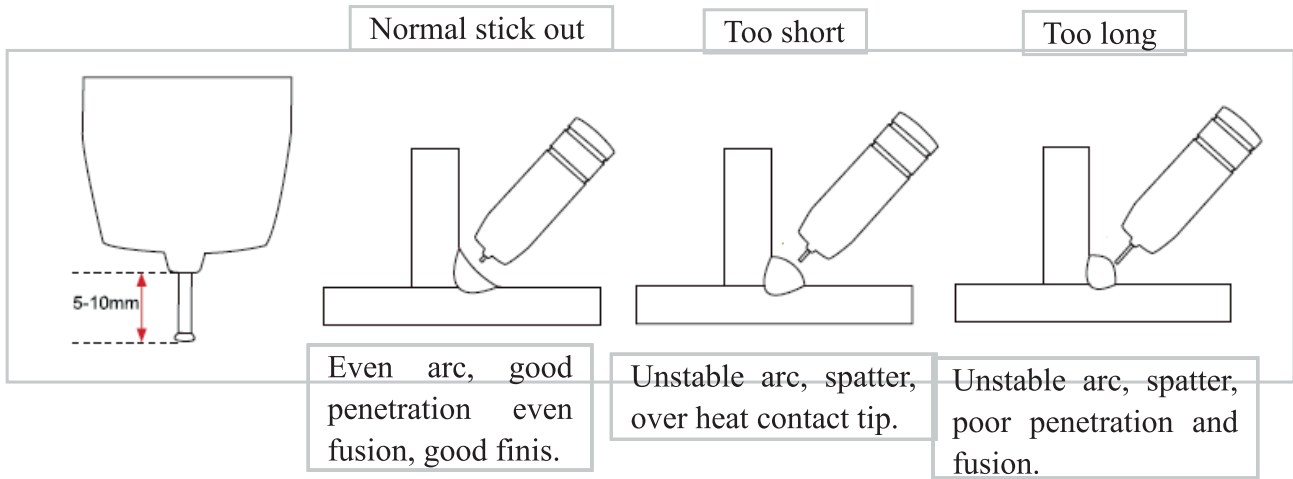

Travel Speed - Travel speed is the rate that the gun is moved along the weld joint and is usually measured in mm per minute. Travel speeds can vary depending on conditions and the welders skill and is limited to the welders ability to control the weld pool. Push technique allows faster travel speeds than Drag technique. Gas flow must also correspond with the travel speed, increasing with faster travel speed and decreasing with slower speed. Travel speed needs to match the amperage and will decrease as the material thickness and amperage increase.

Too Fast Travel Speed - A too fast travel speed produces too little heat per mm of travel resulting in less penetration and reduced weld fusion, the weld bead solidifies very quickly trapping gases inside the weld metal causing porosity. Undercutting of the base metal can also occur and an unfilled groove in the base metal is created when the travel speed is too fast to allow molten metal to flow into the weld crater created by the arc heat.

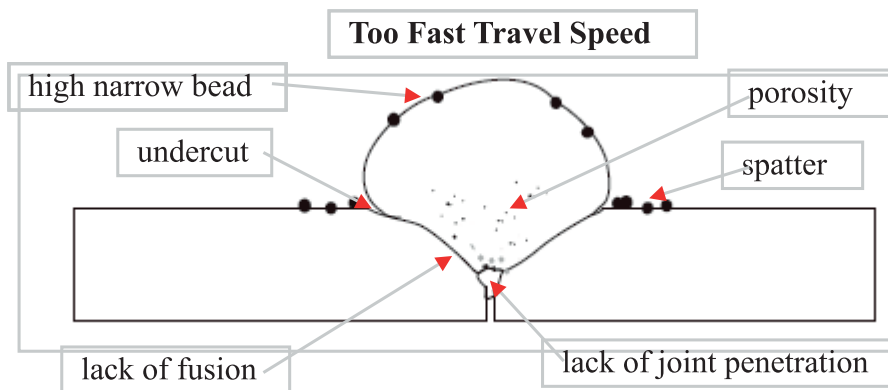

Too Slow Travel Speed - A too slow travel speed produces a large weld with lack of penetration and fusion. The energy from the arc dwells on top of the weld pool rather than penetrating the

base metal. This produces a wider weld bead with more deposited weld metal per mm than is required resulting in a weld deposit of poor quality.

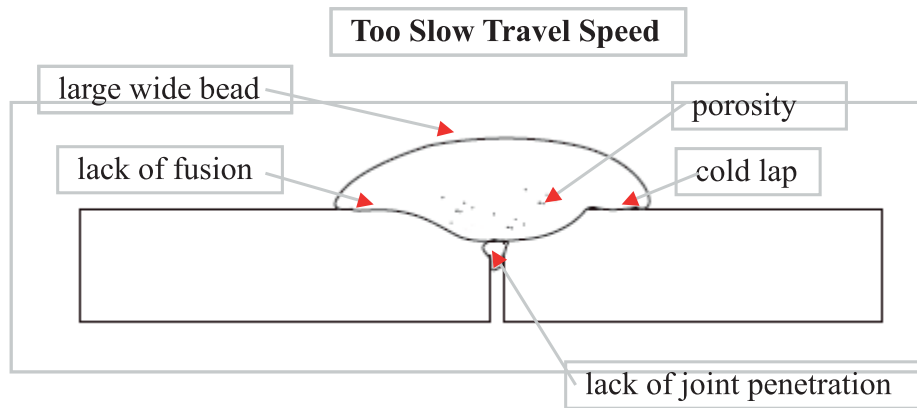

Correct Travel Speed - The correct travel speed keeps the arc at the leading edge of the weld pool allowing the base metal to melt sufficiently to create good penetration, fusion and wetting out of the weld pool producing a weld deposit of good quality.

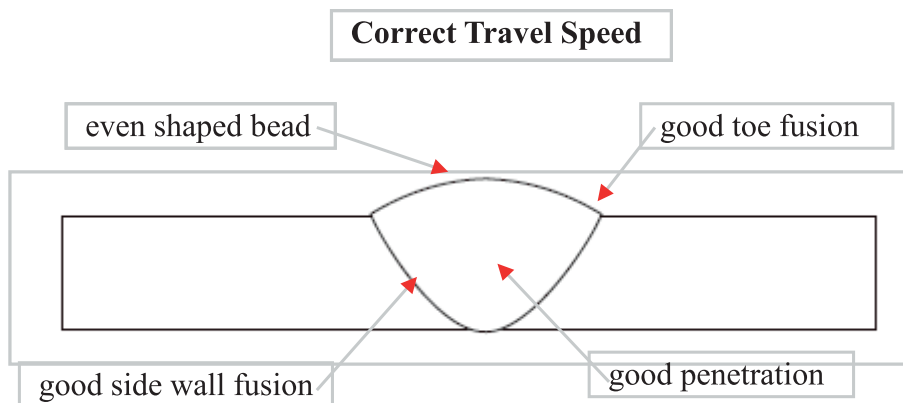

Wire types and sizes - Use the correct wire type for the base metal being welded. Use stainless steel wire for stainless steel, aluminium wires for aluminium and steel wires for steel.

Use a smaller diameter wire for thin base metals. For thicker materials use a larger wire diameter and larger machine, check the recommended welding capability of you machine. As a guide refer to the “Welding Wire Thickness Chart” below.



EZIMIG215C

WELDING WIRE DIAMETER CHART

MATERIAL THICKNESS	RECOMMENDED WIRE DIAMETERS				
	0.8	0.9	1.0	1.2	1.6
0.8mm					
0.9mm					
1.0mm					
1.2mm					
1.6mm					
2.0mm					
2.5mm					
3.0mm					
4.0mm					
5.0mm					
6.0mm					
8.0mm					
10mm					
14mm					
18mm					
22mm					

For material thickness of 5.0mm and greater, multi-pass runs or a beveled joint design may be required depending on the amperage capability of your machine.

Gas selection - The purpose of the gas in the MIG process is to protect / shield the wire, the arc and the molten weld metal from the atmosphere. Most metals when heated to a molten state will react with the air in the atmosphere, without the protection of the shielding gas the weld produced would contain defects like porosity, lack of fusion and slag inclusions. Additionally some of the gas becomes ionised (electrically charged) and helps the current flow smoothly.

The correct gas flow is also very important in protecting the welding zone from the atmosphere. Too low flow will give inadequate coverage and result in weld defects and unstable arc conditions. Too high flow can cause air to be drawn into the gas column and contaminate the weld zone.

Use the correct shielding gas. CO2 is good for steel and offers good penetration characteristics, the weld profile is narrower and slightly more raised than the weld profile obtained from Argon Co2 mixed gas. Argon CO2 mix gas offers better weld ability for thin metals and has a wider range of setting tolerance on the machine. Argon 80% CO2 20% is a good all round mix suitable for most applications.



EZIMIG215C

Argon Co2 CO2

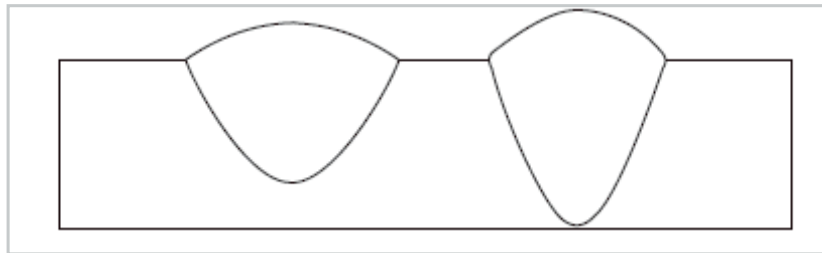

Penetration Pattern for Steel

3.2 Installation & Operation for Stick Welding

3.2.1 Set up installation for Stick Welding

Connection of Output Cables

Connection of Output Cables Two sockets are available on this welding machine. For MMA welding the electrode holder is shown be connected to the positive socket, while the earth lead (work piece) is connected to the negative socket, this is known as DCEP. However various electrodes require a different polarity for optimum results and careful attention should be paid to the polarity, refer to the electrode manufacturers information for the correct polarity.

DCEP: Electrode connected to “+” output socket.

DCEN: Electrode connected to “-” output socket.

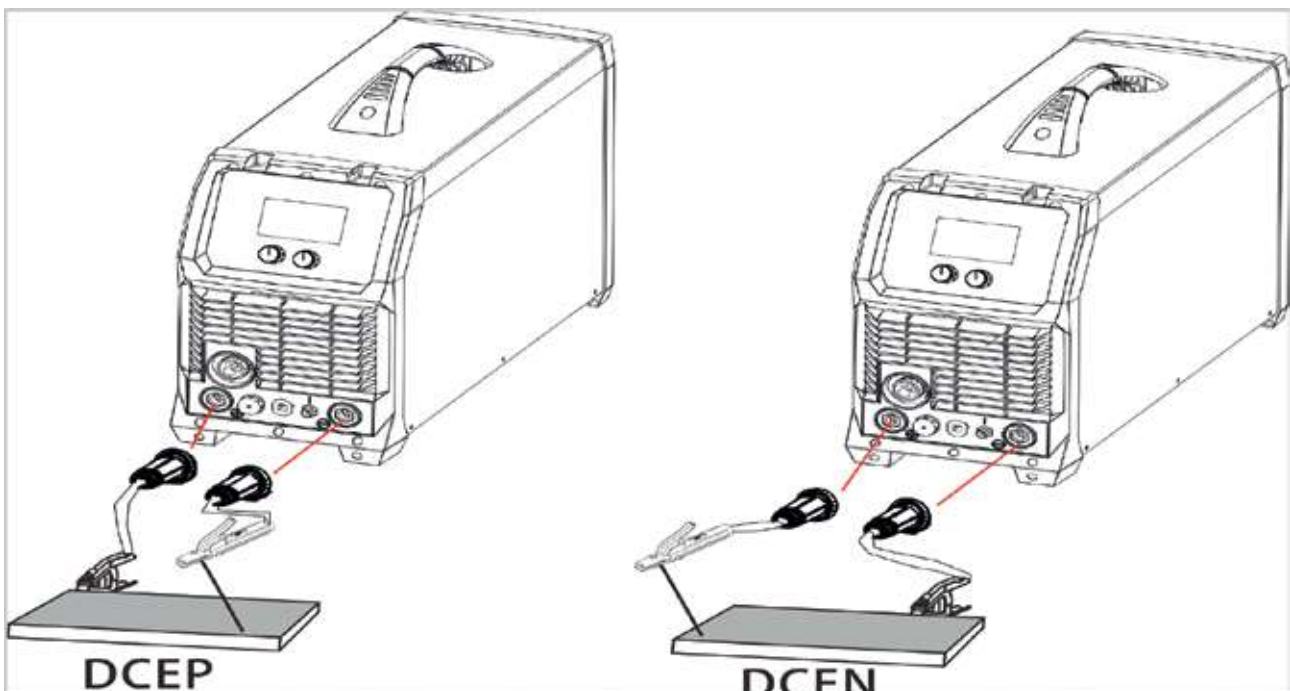

3.2.2 Stick (MMA) Welding

One of the most common types of arc welding is manual metal arc welding (MMA) or stick welding. An electric current is used to strike an arc between the base material and a consumable electrode rod or 'stick'. The electrode rod is made of a material that is compatible with the base material being welded and is covered with a flux that gives off gaseous vapours that serve as a shielding gas and providing a layer of slag, both of which protect the weld area from atmospheric contamination. The electrode core itself acts as filler material the residue from the flux that forms slag covering over the weld metal must be chipped away after welding.

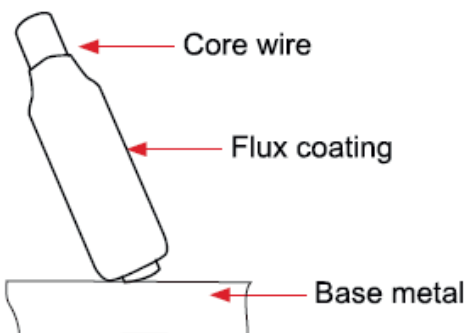
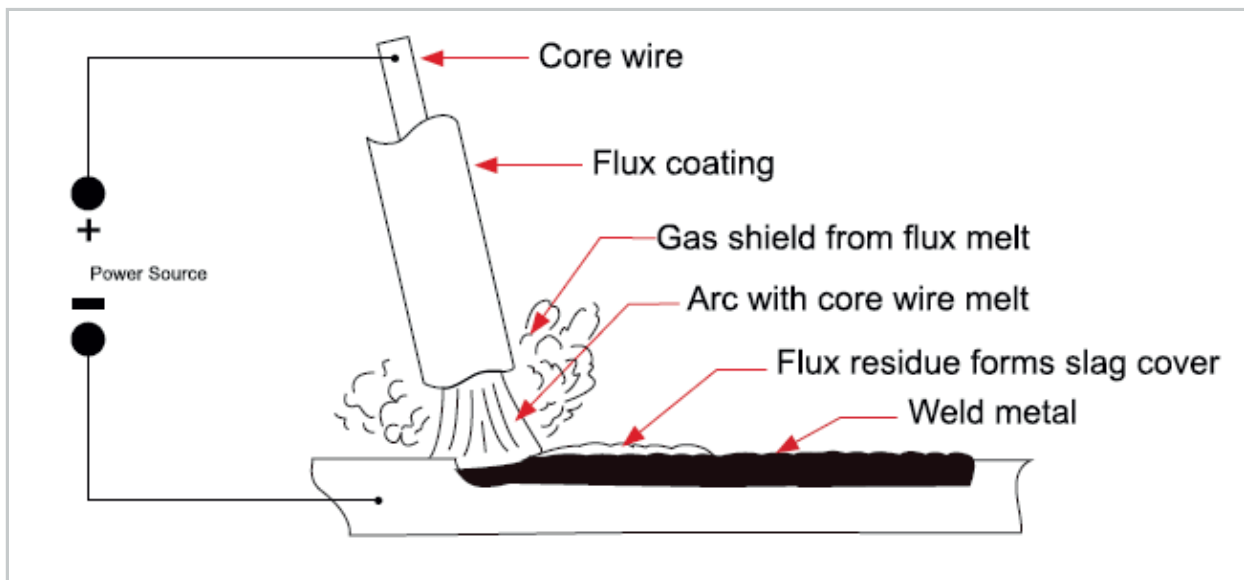

- The arc is initiated by momentarily touching the electrode to the base metal.
- The heat of the arc melts the surface of the base metal to form a molten pool at the end of the electrode.
- The melted electrode metal is transferred across the arc into the molten pool and becomes the deposited weld metal.
- The deposit is covered and protected by a slag which comes from the electrode coating.
- The arc and the immediate area are enveloped by an atmosphere of protective gas.

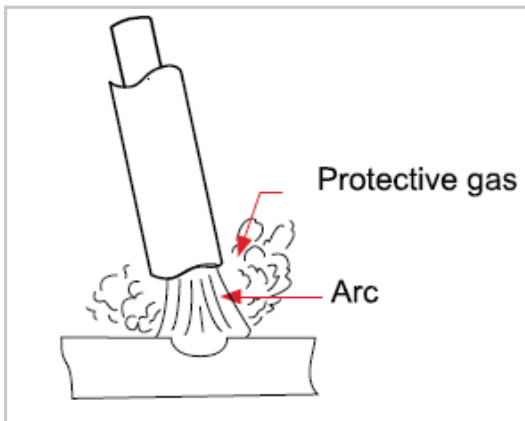

Manual metal arc (stick) electrodes have a solid metal wire core and a flux coating. These electrodes are identified by the wire diameter and by a series of letters and numbers. The letters and numbers identify the metal alloy and the intended use of the electrode.

The **Metal Wire Core** works as conductor of the current that maintains the arc. The core wire melts and is deposited into the welding pool.

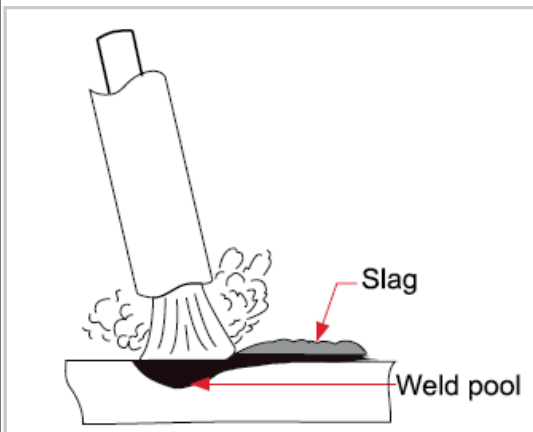

The covering on a shielded metal arc welding electrode is called **Flux**.

The flux on the electrode performs many different functions.

These include:

- producing a protective gas around the weld area
- providing fluxing elements and deoxidizer
- creating a protective slag coating over the weld as it cools
- establishing arc characteristics
- adding alloying elements.

Covered electrodes serve many purposes in addition to filler metal to the molten pool. These additional functions are provided mainly by the covering on the electrode.

3.2.3 Stick (MMA) Welding Fundamentals

Electrode Selection

As a general rule, the selection of an electrode is straight forward, in that it is only a matter of selecting an electrode of similar composition to the parent metal. However, for some metals there is a choice of several electrodes, each of which has particular properties to suit specific classes of work. It is recommended to consult your welding supplier for the correct selection of electrode.



Electrode Size

Average Thickness of Material	Maximum Recommended Electrode Diameter
1.0-2.0 mm	2.5 mm
2.0-5.0 mm	3.2 mm
5.0-8.0 mm	4.0 mm
>8.0 mm	5.0 mm

The size of the electrode generally depends on the thickness of the section being welded, and the thicker the section the larger the electrode required. The table gives the maximum size of electrodes that maybe used for various thicknesses of section base on using a general purpose type 6013 electrode.

Welding Current (Amperage)

Electrode Size ϕ mm	Current Range (Amps)
2.5 mm	60-95
3.2 mm	100-130
4.0 mm	130-165
5.0 mm	165-260

Correct current selection for a particular job is an important factor in arc welding. With the current set too low, difficulty is experienced in striking and maintaining a stable arc. The electrode tends to stick to the work, penetration is poor and beads with a distinct rounded profile will be deposited. Too high current is accompanied by overheating of the

electrode resulting undercut and burning through of the base metal and producing excessive spatter. Normal current for a particular job may be considered as the maximum, which can be used without burning through the work, over-heating the electrode or producing a rough spattered surface. The table shows current ranges generally recommended for a general purpose type 6013 electrode.

Arc Length

To strike the arc, the electrode should be gently scraped on the work until the arc is established. There is a simple rule for the proper arc length; it should be the shortest arc that gives a good surface to the weld. An arc too long reduces penetration, produces spatter and gives a rough surface finish to the weld. An excessively short arc will cause sticking of the electrode and result in poor quality welds. General rule of thumb for down hand welding is to have an arc length no greater than the diameter of the core wire.



EZIMIG215C

Electrode Angle

The angle that the electrode makes with the work is important to ensure a smooth, even transfer of metal. When welding in down hand, fillet, horizontal or overhead the angle of the electrode is generally between 5 and 15 degrees towards the direction of travel. When vertical up welding the angle of the electrode should be between 80 and 90 degrees to the work piece.

Travel Speed

The electrode should be moved along in the direction of the joint being welded at a speed that will give the size of run required. At the same time, the electrode is fed downwards to keep the correct arc length at all times. Excessive travel speeds lead to poor fusion, lack of penetration etc, while too slow a rate of travel will frequently lead to arc instability, slag inclusions and poor mechanical properties.

Material and Joint Preparation

The material to be welded should be clean and free of any moisture, paint, oil, grease, mill scale, rust or any other material that will hinder the arc and contaminate the weld material. Joint preparation will depend on the method used include sawing, punching, shearing, machining, flame cutting and others. In all cases edges should be clean and free of any contaminants. The type of joint will be determined by the chosen application.

3.3 Installation & Operation for TIG Welding

3.3.1 Set up installation for TIG Welding

- (1) Insert the earth cable plug into the positive socket on the front of the machine and tighten it.
- (2) Plug the welding torch into the negative socket on the front panel, and tighten it.
- (3) Connect the control cable of torch switch to 9 pin socket on the front of the machine .
- (4) Connect the gas line of TIG Gun to outlet gas connector on the front of the machine . **Check for Leaks!**
- (5) Connect the gas regulator to the Gas Cylinder and connect the gas line to the Gas Regulator. **Check for Leaks!**
- (6) Connect the gas line to the machine inlet gas connector via the quick push lock connector



EZIMIG215C

located on the rear panel. **Check for Leaks!**

(7) Connect the power cable of welding machine with the output switch in electric box on site.

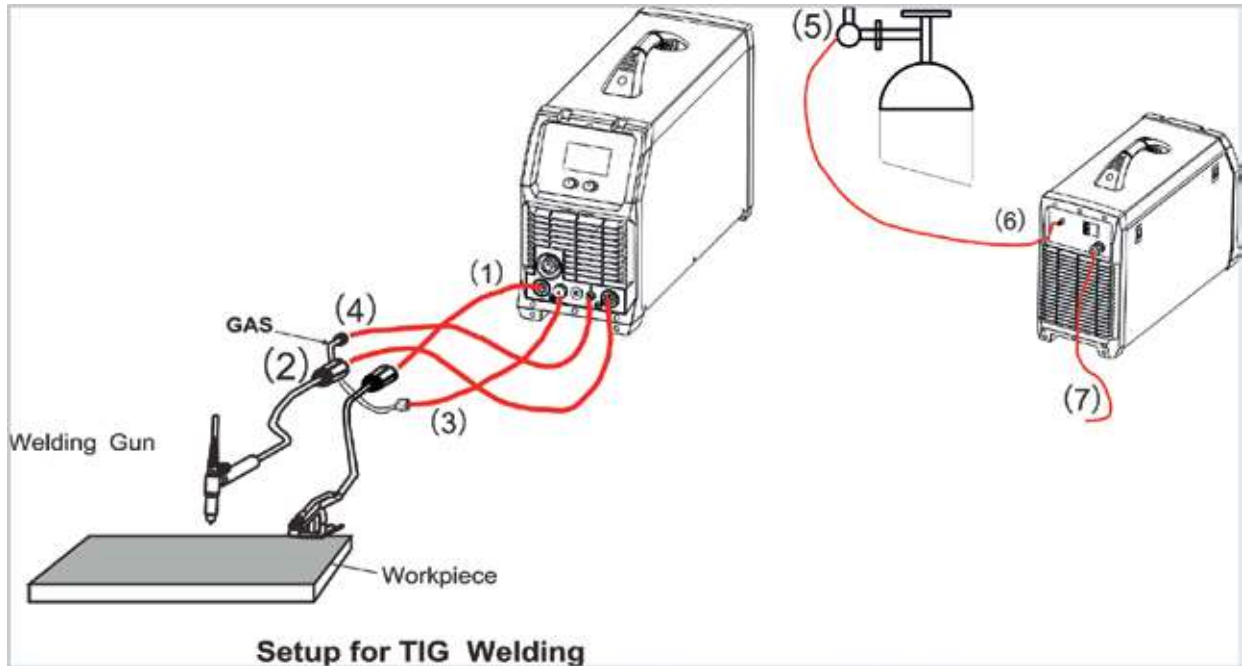

3.3.2 Operation of the TIG Lift welding method

1. Selection of the welding method:

- 1) In the main interface, press the MENU key to enter the function selection interface;
- 2) In the function selection interface, rotate L Knob to select the TIG Lift welding method and press it for confirmation. Refer to Fig. 1;



EZIMIG215C

2. Selection and setting of welding parameters:

- 1) In the main interface, press the MENU key to enter the welding parameter setting interface;
- 2) In the welding parameter setting interface, rotate L Knob to select the parameter as required and rotate R Knob to set a value for the parameter, afterwards, press L Knob or R Knob for confirmation as shown below:

Welding parameters available by rotating L Knob	Welding parameters available by rotating R Knob
Two/four Stroke	2T/4T
Pre-flow	0-2 S
Down Slope	0-10 S
Post Flow	0-10 S

3. Setting of welding current:

- 1) Press the ENTER key to enter the welding interface as shown below:
 - 2) In the welding interface, rotate L Knob to set the welding current, and then press it for confirmation;
4. Assemble front end parts for Lift ARC DC TIG torch making sure they are correctly assembled, use the correct size and type of tungsten electrode for the job, the tungsten electrode requires a sharpened point for DC welding.





EZIMIG215C

5. Lay the outside edge of the Gas Cup on the work piece with the Tungsten Electrode 1- 2mm from the work piece. Press and hold the torch switch to activate to gas flow and welding power.



6. With a small movement rotate the Gas Cup forward so that the Tungsten Electrode touches the work piece.



7. Now rotate the Gas Cup in the reverse direction to lift the Tungsten electrode from the work piece to create the arc.



(8) Release the trigger to stop the welding.



IMPORTANT! - We strongly recommend that you check for gas leaks prior to operation of your machine. We recommend that you close the cylinder valve when the machine is not in use.

3.3.3 DC TIG Welding

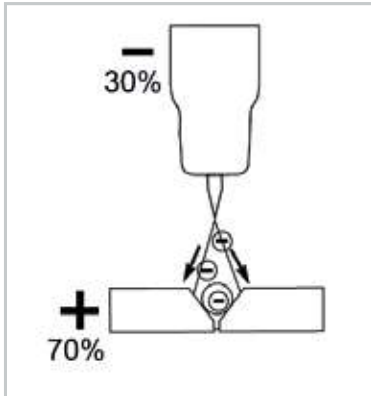

The DC power source uses what is known as DC (direct current) in which the main electrical component known as electrons flow in only one direction from the negative pole (terminal) to the positive pole (terminal). In the DC electrical circuit there is an electrical principle at work which should always be taken into account when using any DC circuit. With a DC circuit 70% of the energy (heat) is always on the positive side. This needs to be understood because it determines what

terminal the TIG torch will be connected to (this rule applies to all the other forms of DC welding as well).

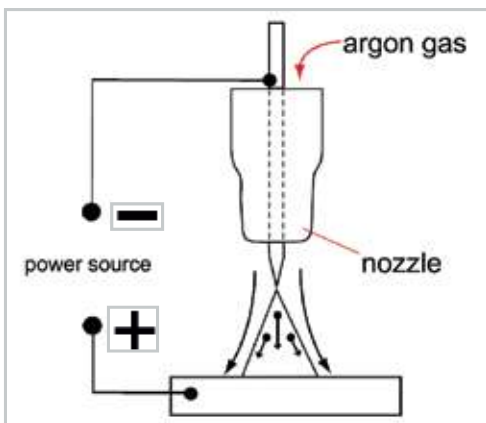

DC TIG welding is a process in which an arc is struck between a TUNGSTEN electrode and the metal work piece. The weld area is shielded by an inert gas flow to prevent contamination of the tungsten, molten pool and weld area. When the TIG arc is struck the inert gas is ionized and superheated changing its molecular structure which converts

it into a plasma stream. This plasma stream flowing between the tungsten and the work piece is the TIG arc and can be as hot as 19,000°C. It is a very pure and concentrated arc which provides the controlled melting of most metals into a weld pool. TIG welding offers the user the greatest amount of flexibility to weld the widest range of material and thickness and types. DC TIG welding is also the cleanest weld with no sparks or spatter.

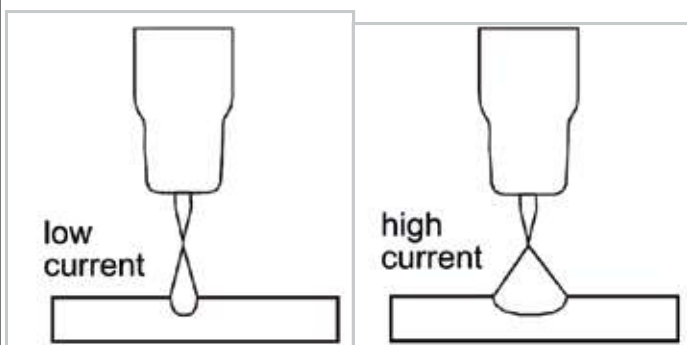

The intensity of the arc is proportional to the current that flows from the tungsten. The welder regulates the welding current to adjust the power of the arc. Typically thin material requires a less powerful arc with less heat to melt the material so less current (amps) is



required, thicker material requires a more powerful arc with more heat so more current (amps) are necessary to melt the material.

LIFT ARC IGNITION for TIG (tungsten inert gas) Welding

Lift Arc is a form of arc ignition where the machine has low voltage on the electrode to only a few volts, with a current limit of one or two amps (well below the limit that causes metal to transfer and contamination of the weld or electrode). When the machine detects that the tungsten has left the surface and a spark is present, it immediately (within microseconds) increases power, converting the spark to a full arc. It is a simple, safe lower cost alternative arc ignition process to HF (high frequency) and a superior arc start process to scratch start.

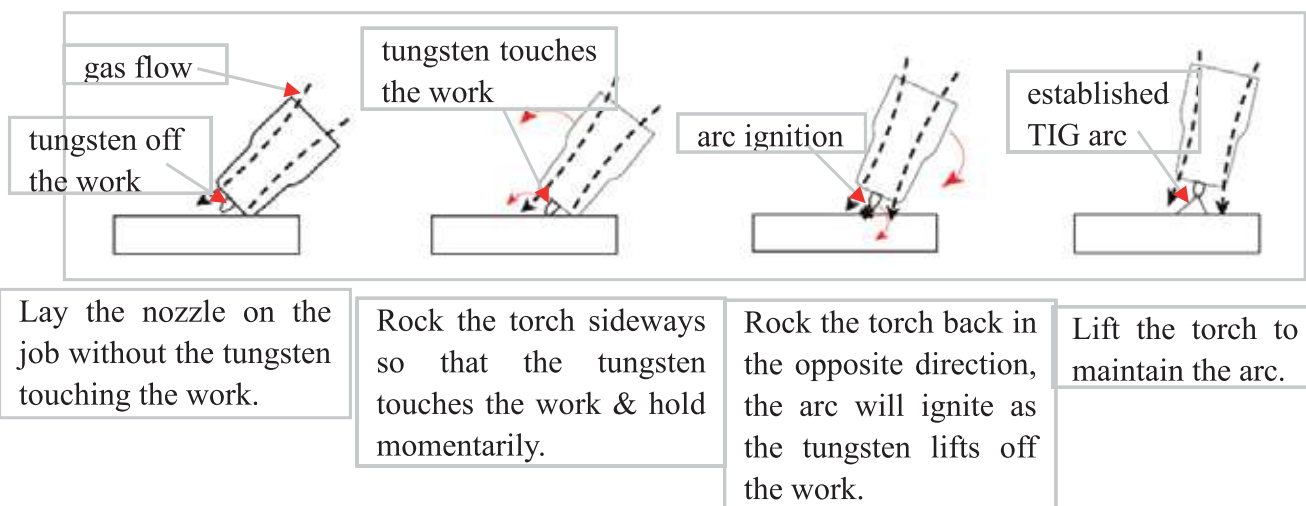

3.3.4 TIG Welding Fusion Technique

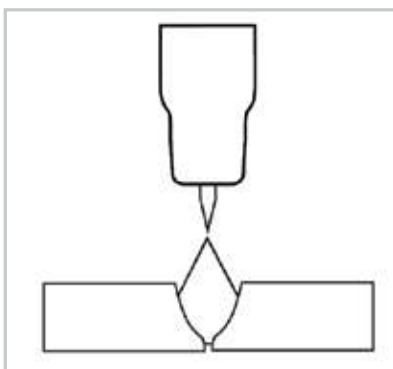

Manual TIG welding is often considered the most difficult of all the welding processes. Because the welder must maintain a short arc length, great care and skill are required to prevent contact between the electrode and the work piece. Similar to Oxygen Acetylene torch welding, Tig welding normally requires two hands and in most instances requires the welder to manually feed a filler wire into the weld pool with one hand while manipulating the welding torch in the other. However, some welds combining thin materials can be accomplished without filler metal like edge, corner, and butt joints. This is known as Fusion welding where the edges of the metal pieces are melted together using only the heat and arc force generated by the TIG arc. Once the arc is started the torch

tungsten is held in place until a weld pool is created, a circular movement of the tungsten will assist in creating a weld pool of the desired size. Once the weld pool is established tilt the torch at about a 75° angle and move smoothly and evenly along the joint while fusing the materials together.

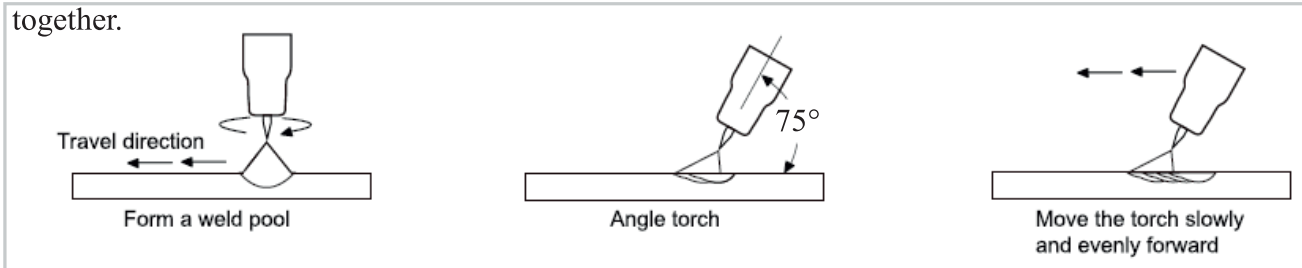

TIG Welding with Filler Wire Technique

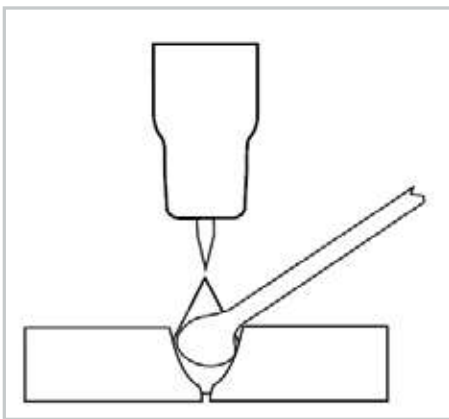

It is necessary in many situations with TIG welding to add a filler wire into the weld pool to build up weld reinforcement and create a strong weld. Once the arc is started the tungsten is held in place until a weld pool is created, a circular movement of the tungsten will assist in creating a weld pool of the desired size. Once the weld pool is established tilt the torch at about a 75° angle and move smoothly and evenly along the joint.

The filler metal is introduced to the leading edge of the weld pool. The filler wire is usually held at about a 15° angle and fed into the leading edge of the molten pool, the arc will melt the filler wire into the weld pool as the torch is moved forward. Also a dabbing technique can be used to control the amount of filler wire added, the wire is fed into the molten pool and retracted in a repeating sequence as the torch is moved slowly and evenly forward. It is important during the welding to keep the molten end of the filler wire inside the gas shield as this protects the end of the wire from being oxidised and contaminating the weld pool.

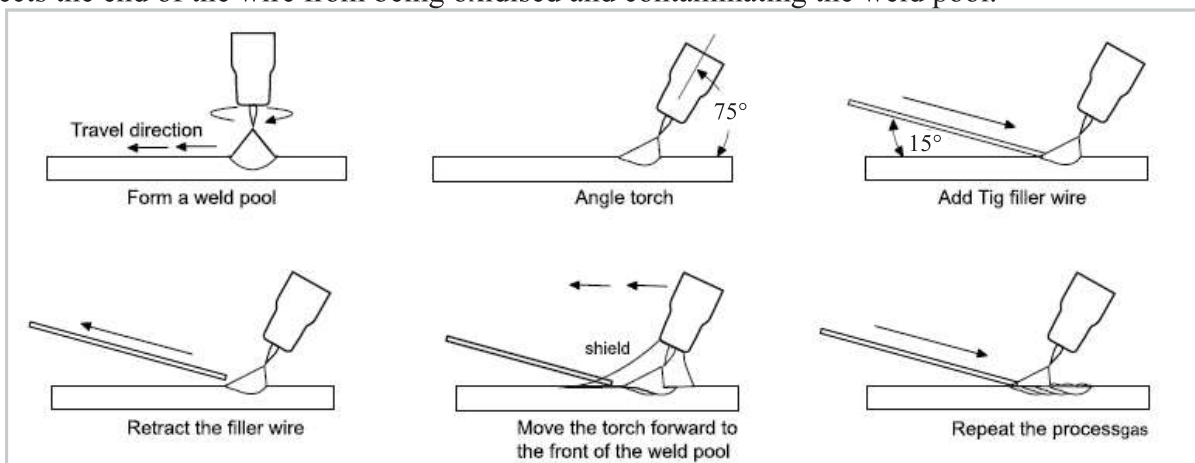



3.3.5 Tungsten Electrodes

Tungsten is a rare metallic element used for manufacturing TIG welding electrodes. The TIG process relies on tungsten's hardness and high-temperature resistance to carry the welding current to the arc. Tungsten has the highest melting point of any metal, 3,410 degrees Celsius. Tungsten electrodes are nonconsumable and come in a variety of sizes, they are made from pure tungsten or an alloy of tungsten and other rare earth elements. Choosing the correct tungsten depends on the material being welded, amps required and whether you are using AC or DC welding current. Tungsten electrodes are colour-coded at the end for easy identification. Below are the most commonly used tungsten electrodes found in the New Zealand and Australian market.

Thoriated (Colour Code: Red)



Thoriated tungsten electrodes (AWS classification EWTh-2) contain a minimum of 97.30 percent tungsten and 1.70 to 2.20 percent thorium and are called 2 percent thoriated. They are the most commonly used electrodes today and are preferred for their longevity and ease of use.

Thoriated tungsten should not get in contact with open cuts or wounds. The more significant danger to welders can occur when thorium oxide gets into the lungs. This can happen from the exposure to vapours during welding or from ingestion of material/dust in the grinding of the tungsten. Follow the manufacturer's warnings, instructions, and the Material Safety Data Sheet (MSDS) for its use.

E3 (Color Code: Purple)



E3 tungsten electrodes (AWS classification EWG) contain a minimum of 98% percent tungsten and up to 1.5 percent Lanthanum and small percentages of Zirconium and Yttrium they are called E3 Tungsten. E3 Tungsten Electrodes provide conductivity similar to that of thoriated electrodes. Typically, this means that E3 Tungsten Electrodes are exchangeable with thoriated electrodes without requiring significant welding process changes. E3 deliver superior arc starting, electrode lifetime, and overall cost-effectiveness. When E3 Tungsten Electrodes are compared with 2% thoriated tungsten, E3 requires fewer re-grinds and provides a longer overall lifetime. Tests have shown that ignition delay with E3 Tungsten Electrodes actually improves over time, while 2% thoriated tungsten starts to deteriorate after only 25 starts. At equivalent energy output, E3



EZIMIG215C

Tungsten Electrodes run cooler than 2% thoriated tungsten, thereby extending overall tip lifetime. E3 Tungsten Electrodes work well on AC or DC. They can be used DC electrode positive or negative with a pointed end, or balled for use with AC power sources.

Ceriated (Color Code: Orange)



Ceriated tungsten electrodes (AWS classification EWCe-2) contain a minimum of 97.30 percent tungsten and 1.80 to 2.20 percent cerium and are referred to as 2 percent ceriated. Ceriated tungstens perform best in DC welding at low current settings. They have excellent arc starts at low amperages and become popular in such applications as orbital tube welding, thin sheet metal work. They are best used to weld carbon steel, stainless steel, nickel alloys, and titanium, and in some cases it can replace 2 percent thoriated electrodes. Ceriated tungsten is best suited for lower amperages it should last longer than Thoriated tungsten higher amperage applications are best left to Thoriated or Lanthanated tungsten.

Lanthanated (Color Code: Gold)



Lanthanated tungsten electrodes (AWS classification EWLa-1.5) contain a minimum of 97.80 percent tungsten and 1.30 percent to 1.70 percent lanthanum, and are known as 1.5 percent lanthanated. These electrodes have excellent arc starting, a low burn off rate, good arc stability, and excellent re-ignition characteristics. Lanthanated tungstens also share the conductivity characteristics of 2 percent thoriated tungsten. Lanthanated tungsten electrodes are ideal if you want to your welding capabilities. They work well on AC or DC electrode negative with a pointed end, or they can be balled for use with AC sine wave power sources. Lanthanated tungsten maintains a sharpened point well, which is an advantage for welding steel and stainless steel on DC or AC from square wave power sources.

Zirconiated (Color Code: White)



Zirconiated tungsten electrodes (AWS classification EWZr-1) contain a minimum of 99.10 percent tungsten and 0.15 to 0.40 percent zirconium. Most commonly used for AC welding Zirconiated tungsten produces a very stable arc and is resistant to tungsten spitting. It is ideal for AC welding because it retains a balled tip and has a high resistance to contamination. Its current-carrying capacity is equal to or greater than that of thoriated tungsten. Zirconiated tungsten is not recommended for DC welding.



Tungsten Electrodes Rating for Welding Currents

Tungsten Diameter mm	DC Current Amps Torch Negative 2% Thoriated	AC Current Amps Un-Balanced Wave 0.8% Zirconiated	AC Current Amps Balanced Wave 0.8% Zirconiated
1.0mm	15-80	15-80	20-60
1.6mm	70-150	70-150	60-120
2.4mm	150-250	140-235	100-180
3.2mm	250-400	225-325	160-250
4.0mm	400-500	300-400	200-320

3.3.6 Tungsten Preparation

Always use **DIAMOND** wheels when grinding and cutting. While tungsten is a very hard material, the surface of a diamond wheel is harder, and this makes for smooth grinding. Grinding without diamond wheels, such as aluminium oxide wheels, can lead to jagged edges, imperfections, or poor surface finishes not visible to the eye that will contribute to weld inconsistency and weld defects.

Always ensure to grind the tungsten in a longitudinal direction on the grinding wheel. Tungsten electrodes are manufactured with the molecular structure of the grain running lengthwise and thus grinding crosswise is “grinding against the grain.” If electrodes are ground crosswise, the electrons have to jump across the grinding marks and the arc can start before the tip and wander. Grinding longitudinally with the grain, the electrons flow steadily and easily to the end of the tungsten tip. The arc starts straight and remains narrow, concentrated, and stable.

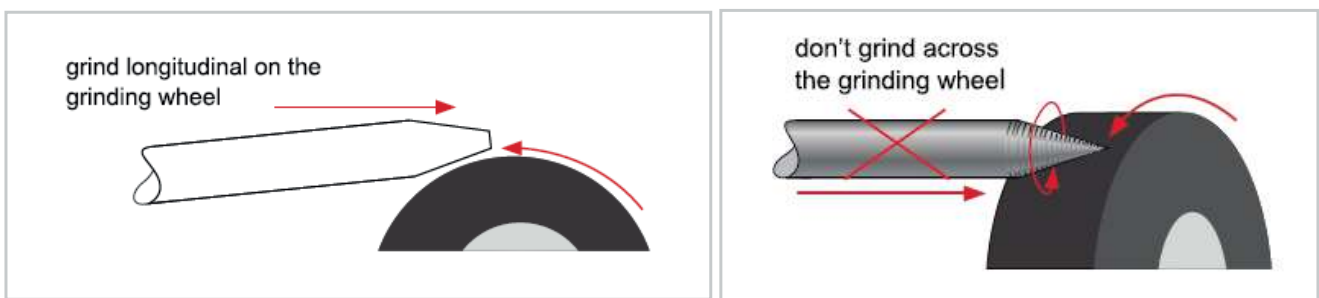

Electrode Tip/Flat

The shape of the tungsten electrode tip is an important process variable in precision arc welding. A good selection of tip/flat size will balance the need for several advantages. The bigger the flat, the more likely arc wander will occur and the more difficult it will be to arc start. However, increasing the flat to the maximum level that still allows arc start and eliminates arc wander will improve the weld penetration and increase the electrode life. Some welders still grind electrodes to a sharp point, which makes arc starting easier. However, they risk decreased welding performance from melting at the tip and the possibility of the point falling off into the weld pool.



Electrode Included Angle/Taper - DC Welding

Tungsten electrodes for DC welding should be ground longitudinally and concentrically with diamond wheels to a specific included angle in conjunction with the tip/flat preparation. Different angles produce different arc shapes and offer different weld penetration capabilities. In general, blunter electrodes that have a larger included angle provide the following benefits:

- Last Longer
- Have better weld penetration
- Have a narrower arc shape
- Can handle more amperage without eroding.

Sharper electrodes with smaller included angle provide:

- Offer less arc weld
- Have a wider arc
- Have a more consistent arc

The included angle determines weld bead shape and size. Generally, as the included angle increases, penetration increases and bead width decreases.

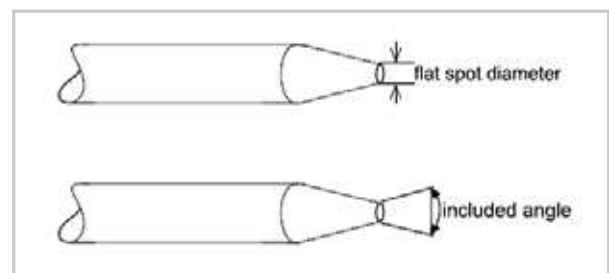



EZIMIG215C

MAINTENANCE AND TROUBLESHOOTING

Tungsten Diameter	Diameter at the Tip - mm	Constant Included Angle - Degrees	Current Range Amps	Current Range Pulsed Amps
1.0mm	.250	20	05 - 30	05 - 60
1.6mm	.500	25	08 - 50	05 - 100
1.6mm	.800	30	10 - 70	10 - 140
2.4mm	.800	35	12 - 90	12 - 180
2.4mm	1.100	45	15 - 150	15 - 250
3.2mm	1.100	60	20 - 200	20 - 300
3.2mm	1.500	90	25 - 250	25 - 350

3.3.7 Tig Gun switch control

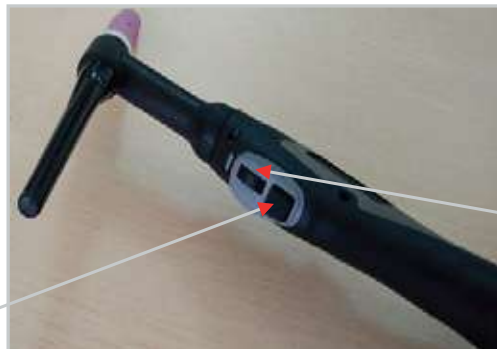

Gun switch

Adjust current roller wheel, when it's roll upwards, the current increase, when it's roll downwards, the current decrease.

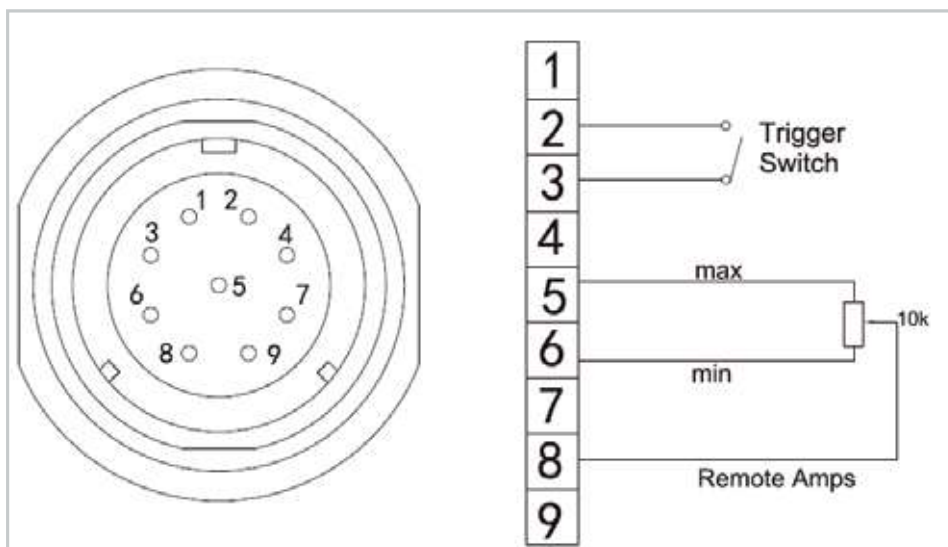

Remote Control Socket



EZIMIG215C

MAINTENANCE AND TROUBLESHOOTING

Socket Pin	Function
1	Not connected
2	Trigger Switch Input
3	Trigger Switch Input
4	Not connected
5	10k ohm (maximum) connection to 10k ohm remote control potentiometer
6	Zero ohm (minimum) connection to 10k ohm remote control potentiometer
7	Not connected
8	Wiper arm connection to 10k ohm remote control potentiometer
9	Not connected

3.4 Operation environment

- ▲ Height above sea level ≤ 1000 M
- ▲ Operation temperature range $-10 \sim +40^{\circ}\text{C}$
- ▲ Air relative humidity is below 90 % (20°C)
- ▲ Preferable site the machine some angles above the floor level, the maximum angle does not exceed 15° .
- ▲ Protect the machine against heavy rain AND against direct sunshine.
- ▲ The content of dust, acid, corrosive gas in the surrounding air or substance cannot exceed normal standard.
- ▲ Take care that there is sufficient ventilation during welding. There must be at least 30cm free distance between the machine and wall.

3.5 Operation Notices

- ▲ Read Section §1 carefully before starting to use this equipment.
- ▲ Connect the ground wire with the machine directly.
- ▲ Ensure that the input is single-phase: 50/60Hz, 110V/220V $\pm 10\%$.
- ▲ Before operation, none concerned people should not be around the working area and especially children. Do not watch the arc in unprotected eyes.
- ▲ Ensure good ventilation of the machine to improve Duty Cycle.
- ▲ Turn off the engine when the operation finished for energy consumption efficiency.
- ▲ When power switch shuts off protectively because of failure. Don't restart it until problem is resolved. Otherwise, the range of problem will be extended.
- ▲ In case of problems, contact your local dealer if no authorized maintenance staff is available!



4 Welding trouble shooting

4.1 MIG welding trouble shooting

The following chart addresses some of the common problems of MIG welding. In all cases of equipment malfunction, the manufacturer’s recommendations should be strictly adhered to and followed.

NO.	Trouble	Possible Reason	Suggested Remedy
1	Excessive Spatter	Wire feed speed set too high	Select lower wire feed speed
		Voltage too high	Select a lower voltage setting
		Wrong polarity set	select the correct polarity for the wire being used - see machine setup guide
		Stick out too long	Bring the torch closer to the work
		Contaminated base metal	Remove materials like paint, grease, oil, and dirt, including mill scale from base metal
		Contaminated mig wire	Use clean dry rust free wire. Do not lubricate the wire with oil, grease etc
		Inadequate gas flow or too much gas flow	Check the gas is connected, check hoses, gas valve and torch are not restricted. Set the gas flow between 6-12 l/min flow rate. Check hoses and fittings for holes, leaks Protect the welding zone from wind and drafts



EZIMIG215C

MAINTENANCE AND TROUBLESHOOTING

2	Porosity - small cavities or holes resulting from gas pockets in weld metal.	Wrong gas	Check that the correct gas is being used
		Inadequate gas flow or too much gas flow	Check the gas is connected, check hoses, gas valve and torch are not restricted. Set the gas flow between 10 - 15 l/min flow rate. Check hoses and fittings for holes, leaks etc .Protect the welding zone from wind and drafts
		Moisture on the base metal	Remove all moisture from base metal before welding
		Contaminated base metal	Remove materials like paint, grease, oil, and dirt, including mill scale from base metal
		Contaminated mig wire	Use clean dry rust free wire. Do not lubricate the wire with oil, grease etc
		Gas nozzle clogged with spatter, worn or out of shape	Clean or replace the gas nozzle
		Missing or damaged gas diffuser	Replace the gas diffuser
		Mig torch euro connect o-ring missing or damaged	Check and replace the o-ring
3	Wire stubbing during welding	Holding the torch too far away	Bring the torch closer to the work and maintain stick out of 5-10mm
		Welding voltage set too low	Increase the voltage
		Wire Speed set too high	Decrease the wire feed speed
4	Lack of Fusion – failure of weld metal to fuse completely with base metal or a proceeding weld bead.	Contaminated base metal	Remove materials like paint, grease, oil, and dirt, including mill scale from base metal
		Not enough heat input	Select a higher voltage range and /or adjust the wire speed to suit
		Improper welding technique	Keep the arc at the leading edge of the weld pool. Gun angle to work should be between 5 & 15° Direct the arc at the weld joint Adjust work angle or widen groove to access bottom during welding Momentarily hold arc on side walls if using weaving technique



EZIMIG215C

MAINTENANCE AND TROUBLESHOOTING

5	Excessive Penetration – weld metal melting through base metal	Too much heat	Select a lower voltage range and /or adjust the wire speed to suit Increase travel speed
6	Lack of Penetration – shallow fusion between weld metal and base metal	Poor in incorrect joint preparation	Material too thick. Joint preparation and design needs to allow access to bottom of groove while maintaining proper welding wire extension and arc characteristics Keep the arc at the leading edge of the weld pool and maintain the gun angle at 5 & 15° keeping the stick out between 5-10mm
		Not enough heat input	Select a higher voltage range and /or adjust the wire speed to suit Reduce travel speed
		Contaminated base metal	Remove materials like paint, grease, oil, and dirt, including mill scale from base metal

4.2 MIG wire feed trouble shooting

The following chart addresses some of the common WIRE FEED problems during MIG welding. In all cases of equipment malfunction, the manufacturer's recommendations should be strictly adhered to and followed.

NO.	Trouble	Possible Reason	Suggested Remedy
1	No wire feed	Wrong mode selected	Check that the TIG/MMA/MIG selector switch set to MIG position
		Wrong torch selector switch	Check that the Wire Feeder /Spool Gun selector switch is set to Wire Feeder position for MIG welding and Spool Gun when using the Spool gun



EZIMIG215C

MAINTENANCE AND TROUBLESHOOTING

2	Inconsistent / interrupted wire feed	Adjusting wrong dial	Be sure to adjust the wire feed and voltage dials for MIG welding. The amperage dial is for MMA and TIG welding mode
		Wrong polarity selected	Select the correct polarity for the wire being used - see machine setup guide
		Incorrect wire speed setting	Adjust the wire feed speed
		Voltage setting incorrect	Adjust the voltage setting
		Mig torch lead too long	Small diameter wires and soft wires like aluminium don't feed well through long torch leads - replace the torch with a lesser length torch
		Mig torch lead kinked or too sharp angle being held	Remove the kink, reduce the angle or bend
		Contact tip worn, wrong size, wrong type	Replace the tip with correct size and type
		Liner worn or clogged (the most common causes of bad feeding)	Try to clear the liner by blowing out with compressed air as a temporary cure, it is recommended to replace the liner
		Wrong size liner	Install the correct size liner
		Blocked or worn inlet guide tube	Clear or replace the inlet guide tube
		Wire misaligned in drive roller groove	Locate the wire into the groove of the drive roller
		Incorrect drive roller size	Fit the correct size drive roller eg; 0.8mm wire requires 0.8mm drive roller
		Wrong type of drive roller selected	Fit the correct type roller (e.g. knurled rollers needed for flux cored wires)
		Worn drive rollers	Replace the drive rollers
		Drive roller pressure too high	Can flatten the wire electrode causing it to lodge in the contact tip - reduce the drive roller pressure
		Too much tension on wire spool hub	Reduce the spool hub brake tension
Wire crossed over on the spool or tangled	Remove the spool untangle the wire or replace the wire		
Contaminated mig wire	Use clean dry rust free wire. Do not lubricate the wire with oil, grease etc		

4.3 DC TIG welding trouble shooting

The following chart addresses some of the common problems of DC TIG welding. In all cases of equipment malfunction, the manufacturer's recommendations should be strictly adhered to and followed.



EZIMIG215C

MAINTENANCE AND TROUBLESHOOTING

NO.	Trouble	Possible Reason	Suggested Remedy
1	Tungsten burning away quickly	Incorrect Gas or No Gas	Use pure Argon. Check cylinder has gas, connected, turned on and torch valve is open
		Inadequate gas flow	Check the gas is connected, check hoses, gas valve and torch are not restricted.
		Back cap not fitted correctly	Make sure the torch back cap is fitted so that the o-ring is inside the torch body
		Torch connected to DC +	Connect the torch to the DC- output terminal
		Incorrect tungsten being used	Check and change the tungsten type if necessary
		Tungsten being oxidised after weld is finished	Keep shielding gas flowing 10–15 seconds after arc stoppage. 1 second for each 10amps of weld current.
2	Contaminated tungsten	Touching tungsten into the weld pool	Keep tungsten from contacting weld puddle. Raise the torch so that the tungsten is off of the work piece 2 - 5mm
		Touching the filler wire to the tungsten	Keep the filler wire from touching the tungsten during welding, feed the filler wire into the leading edge of the weld pool in front of the tungsten
3	Porosity - poor weld appearance and colour	Wrong gas / poor gas flow /gas leak	Use pure argon. Gas is connected, check hoses, gas valve and torch are not restricted. Set the gas flow between 6-12 l/min. Check hoses and fittings for holes, leaks et
		Contaminated base metal	Remove moisture and materials like paint, grease, oil, and dirt from base metal
		Contaminated filler wire	Remove all grease, oil, or moisture from filler metal
		Incorrect filler wire	Check the filler wire and change if necessary
4	Yellowish residue / smoke on the alumina nozzle & discoloured tungsten	Incorrect Gas	Use pure Argon gas
		Inadequate gas flow	Set the gas flow between 10 - 15 l/min flow rate
		Alumina gas nozzle too small	Increase the size of the alumina gas nozzle



EZIMIG215C

MAINTENANCE AND TROUBLESHOOTING

5	Unstable Arc during DC welding	Torch connected to DC +	Connect the torch to the DC- output terminal
		Contaminated base metal	Remove materials like paint, grease, oil, and dirt, including mill scale from base metal.
		Tungsten is contaminated	Remove 10mm of contaminated tungsten and re grind the tungsten
		Arc length too long	Lower torch so that the tungsten is off of the work piece 2 - 5mm
6	Arc wanders during DC welding	Poor gas flow	Check and set the gas flow between 10 - 15 l/min flow rate
		Incorrect arc length	Lower torch so that the tungsten is off of the work piece 2 - 5mm
		Tungsten incorrect or in poor condition	Check that correct type of tungsten is being used. Remove 10mm from the weld end of the tungsten and re sharpen the tungsten
		Poorly prepared tungsten	Grind marks should run lengthwise with tungsten, not circular. Use proper grinding method and wheel.
		Contaminated base metal or filler wire	Remove contaminating materials like paint, grease, oil, and dirt, including mill scale from base metal. Remove all grease, oil, or moisture from filler metal
7	Arc difficult to start or will not start DC welding	Incorrect machine set up	Check machine set up is correct
		No gas, incorrect gas flow	Check the gas is connected and cylinder valve open, check hoses, gas valve and torch are not restricted. Set the gas flow between 10 - 15 l/min flow rate
		Incorrect tungsten size or type	Check and change the size and or the tungsten if required
		Loose connection	Check all connectors and tighten
		Earth clamp not connected to work	Connect the earth clamp directly to the work piece wherever possible



4.4 MMA welding trouble shooting

The following chart addresses some of the common problems of MMA welding. In all cases of equipment malfunction, the manufacturer's recommendations should be strictly adhered to and followed.

NO.	Trouble	Possible Reason	Suggested Remedy
1	No arc	Incomplete welding circuit	Check earth lead is connected. Check all cable connections.
		Wrong mode selected	Check the MMA selector switch is selected
		No power supply	Check that the machine is switched on and has a power supply
2	Porosity – small cavities or holes resulting from gas pockets in weld metal	Arc length too long	Shorten the arc length
		Work piece dirty, contaminated or moisture	Remove moisture and materials like paint, grease, oil, and dirt, including mill scale from base metal
		Damp electrodes	Use only dry electrodes
3	Excessive Spatter	Amperage too high	Decrease the amperage or choose a larger electrode
		Arc length too long	Shorten the arc length
4	Weld sits on top, lack of fusion	Insufficient heat input	Increase the amperage or choose a larger electrode
		Work piece dirty, contaminated or moisture	Remove moisture and materials like paint, grease, oil, and dirt, including mill scale from base metal
		Poor welding technique	Use the correct welding technique or seek assistance for the correct technique
5	Lack of penetration	Insufficient heat input	Increase the amperage or choose a larger electrode
		Poor welding technique	Use the correct welding technique or seek assistance for the correct technique
		Poor joint preparation	Check the joint design and fit up, make sure the material is not too thick. Seek assistance for the correct joint design and fit up
6	Excessive penetration - burn through	Excessive heat input	Reduce the amperage or use a smaller electrode
		Incorrect travel speed	Try increasing the weld travel speed



EZIMIG215C

MAINTENANCE AND TROUBLESHOOTING

7	Uneven weld appearance	Unsteady hand, wavering hand	Use two hands where possible to steady up, practise your technique
8	Distortion – movement of base metal during welding	Excessive heat input	Reduce the amperage or use a smaller electrode
		Poor welding technique	Use the correct welding technique or seek assistance for the correct technique
		Poor joint preparation and or joint design	Check the joint design and fit up, make sure the material is not too thick. Seek assistance for the correct joint design and fit up
9	Electrode welds with different or unusual arc characteristic	Incorrect polarity	Change the polarity, check the electrode manufacturer for correct polarity



5 Maintenance & Troubleshooting

5.1 Maintenance

In order to guarantee safe and proper operation of welding machines, they must be maintained regularly. Let customers understand the maintenance procedure of welding machines. Enable customers to carry on simple examination and inspections. Do your best to reduce the fault rate and repair times of welding machines to lengthen service life of arc welding machine. Maintenance items in detail are in the following table.

- **Warning: For safety while maintaining the machine, please shut off the main input power and wait for 5 minutes, until capacitors voltage already drop to safe voltage 36V!**

Date	Maintenance items
Daily examination	<p>Observe that the knobs and switches in the front and at the back of arc welding machine are flexible and put correctly in place. If any knob has not been put correctly in place, please correct. If you can't correct or fix the knob, please replace immediately;</p> <p>If any switch is not flexible or it can't be put correctly in place, please replace immediately! Please get in touch with maintenance service department if there are no accessories.</p> <p>After turn-on power, watch/listen if the arc-welding machine has shaking, whistle calling or peculiar smell. If there is one of the above problems, find out the reason and clear it. If you can't find out the reason, please contact your local service repair station or distributor/Agent.</p> <p>Observe that the display value of LED is intact. If the display number is not intact, please replace the damaged LED. If it still doesn't work, please maintain or replace the display PCB.</p> <p>Observe that the min./max.Values on LED agree with the set value. If there is any difference and it has affected the normal welding results, please adjust it.</p> <p>Check whether the fan is damaged and whether it is normal to rotate or control. If the fan is damaged, please change immediately. If the fan does not rotate after the machine is overheated, observe if there is something blocking the blade. If it is blocked, please clear the problem. If the fan does not rotate after getting rid of the above problems, you can poke the blade by the rotation direction of fan. If the fan rotates normally, the start capacity should be replaced. If not, change the fan.</p> <p>Observe whether the fast connector is loose or overheated. If the arc-welding machine has the above problems, it should be fastened or changed.</p> <p>Observe whether the current output cable is damaged. If it is damaged, it should be insulated or changed.</p>



EZIMIG215C

MAINTENANCE AND TROUBLESHOOTING

Monthly examination	Using the dry compressed air to clear the inside of arc welding machine. Especially for clearing up the dusts on radiator, main voltage transformer, inductors, IGBT modules, fast recover diodes, PCB's, etc. Check the screws and bolts in the machine. If any is loose, please screw it tight. If it is shaved, please replace. If it is rusty, please erase rust on all bolts to ensure it works well.
Quarter-yearly examination	Check whether the actual current accords with the displaying value. If they did not accord, they should be regulated. The actual welding current value can be measured by and adjusted by plier-type ampere meter.
Yearly examination	Measure the insulating impedance among the main circuit, PCB and case, if it below $1M\Omega$, insulation is thought to be damaged and need to change, and need to change or strengthen insulation.

5.2 Troubleshooting

- Before the welding machines are dispatched from the factory, they have already been tested and calibrated accurately. **Any alterations, maintenance or repairs performed on Strata welders must be completed by authorized service agents or warranty will be voided**
- Maintenance course must be operated carefully. If any wire becomes flexible or is misplaced, it may cause potential danger to users
- Only authorized service agents can perform maintenance or repairs on the welding machines.
- **Be sure to shut off the Main Input Power before doing any repair work on the welding machine!**
- You must use and authorized service agent for any repairs or maintenance conducted on the welder - contact Strata customer service or your local distributor for more information on service agents

Please see chart below for troubleshooting in the first instance.



EZIMIG215C

MAINTENANCE AND TROUBLESHOOTING

NO.	Problem		Reasons	Solution
1	Close the breaker, but the power light isn't on		Breaker damaged	Change it
			Fuse damaged	Change it
			Input power damaged	Change it
2	After welding machine is over-heat, the fan doesn't work		Fan damaged	Change it
			The cable is loose	Screw the cable tight
3	Press the gun switch, no output shielded gas	No output gas when test gas	No gas in the gas cylinder	Change it
			Gas hose leaks gas	Change it
			Electromagnetic valve damaged	Change it
	Output gas when test gas	Control switch damaged	Repair the switch	
		Control circuit damaged	Check the PCB	
4	Wire-feeder doesn't work	Wire reel doesn't work	Motor damaged	Check and change it
			Control circuit damaged	Check the PCB
		Wire reel works	The press wheel is loosen or weld wire skids	Press it tightly again
			The wheel doesn't fit with the diameter of weld wire	Change the wheel
			Wire reel damaged	Change it
			Wire feed pipe is jammed	Repair or change it
			Tip is jammed because of splash	Repair or change it
5	No striking arc and no output voltage		Output cable is connected incorrectly or loosen	Screw it down or change it
			Control circuit damaged	Check the circuit
6	Welding stops, and alarm light is on		Machine has self-protection	Check over-voltage, over-current, over-temperature, lower-voltage and over-temperature, and solve it
7	Welding current is run away and can be not controlled		The potentiometer damaged	Check or change it
			The control circuit damaged	Check the circuit
8	The crater current can be not adjusted		The PCB damaged	Check it
9	No post-gas		The PCB damaged	Check it



5.3 List of error codes

Error Type	Error code	Description	Lamp status
Thermal relay	E01	Over-heating(1st thermal relay)	Yellow lamp(thermal protection) always on
	E02	Over-heating(2nd thermal relay)	Yellow lamp(thermal protection) always on
	E03	Over-heating(3rd thermal relay)	Yellow lamp(thermal protection) always on
	E04	Over-heating(4th thermal relay)	Yellow lamp(thermal protection) always on
	E09	Over-heating(Program in default)	Yellow lamp(thermal protection) always on
Welding machine	E10	Phase loss	Yellow lamp(thermal protection) always on
	E11	No water	Yellow lamp(lack water) always on
	E12	No gas	Red lamp always on
	E13	Under voltage	Yellow lamp(thermal protection) always on
	E14	Over voltage	Yellow lamp(thermal protection) always on
	E15	Over current	Yellow lamp(thermal protection) always on
	E16	Wire feeder over load	
Switch	E20	Button fault on operating panel when switch on the machine	Yellow lamp(thermal protection) always on
	E21	Other faults on operating panel when switch on the machine	Yellow lamp(thermal protection) always on
	E22	Torch fault when switch on the machine	Yellow lamp(thermal protection) always on
	E23	Torch fault during normal working process	Yellow lamp(thermal protection) always on
Accessory	E30	Cutting torch disconnection	Red lamp blink
	E31	Water cooler disconnection	Yellow lamp(lack water) always on
Communication	E40	Connection problem between wire feeder and power source	
	E41	Communication error	

5.4 Electrical schematic drawing

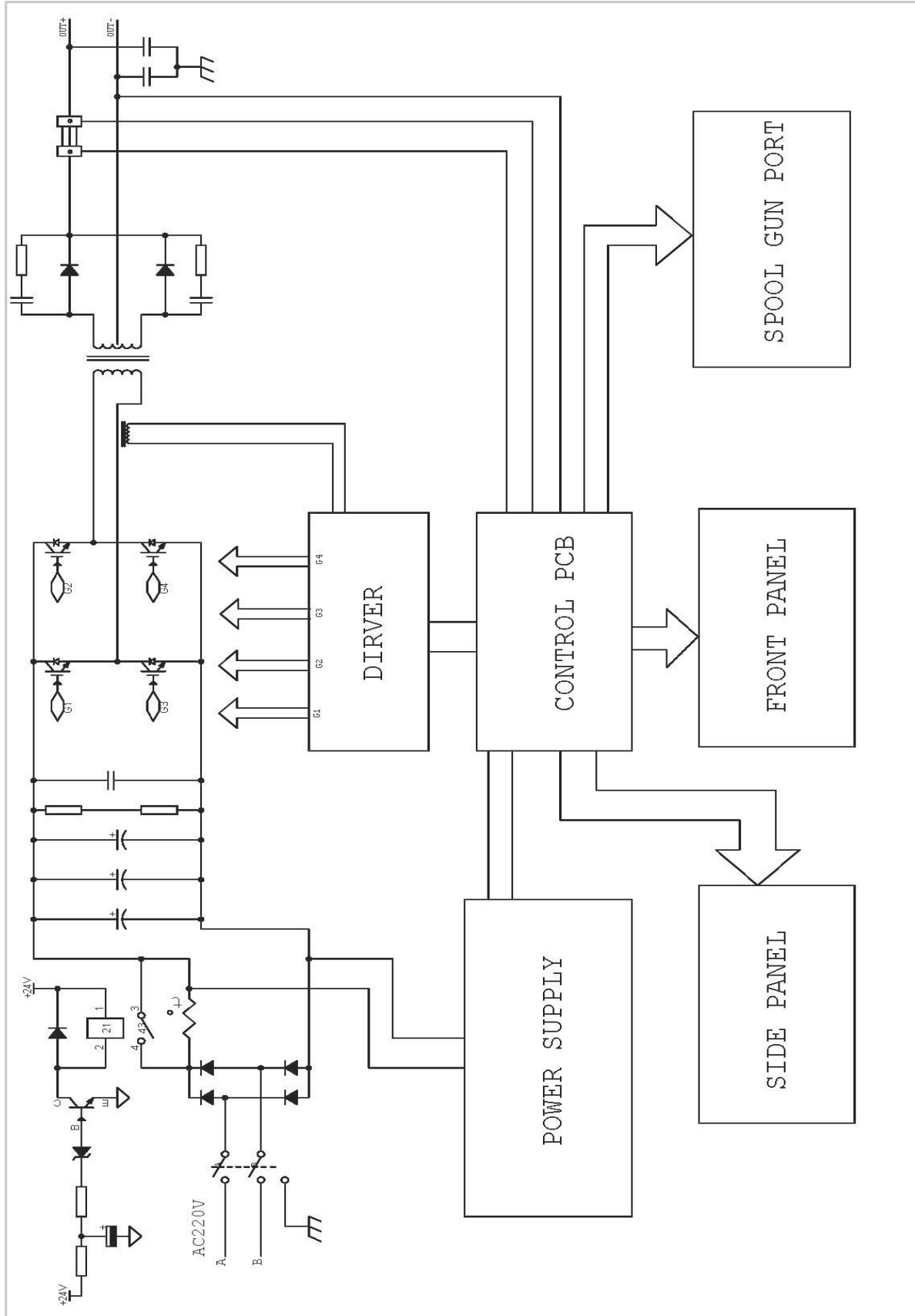



Safety

Store and Retain this Manual

Retain this manual for the safety warnings and precautions, assembly, operating, inspection, maintenance and cleaning procedures. Write the product's serial number into the NOTES section at the rear, and keep this manual and the receipt in a safe and dry place for future reference.

Important Safety Information

Failure to follow the warnings and instructions may result in electric shock, fire, serious injury and/or death. Save all warnings and instructions for future reference.



This is the safety alert symbol to alert you to potential personal injury hazards. Obey all safety messages that follow this symbol to avoid possible injury or death.



DANGER! indicates a hazardous situation which, if not avoided, will result in death or serious injury.



WARNING! indicates a hazardous situation which, if not avoided, could result in death or serious injury.



CAUTION, used with the safety alert symbol, indicates a hazardous situation which, if not avoided, could result in minor or moderate injury.

NOTE, used to address practices not related to personal injury.

General Safety Warnings

1. Maintain labels and nameplates on the welder. These carry important information. If unreadable or missing, contact Euroquip for a replacement.

2. Avoid unintentional starting. Make sure the welder is setup correctly and you are prepared to begin work before turning on the welder.

3. Unplug before performing maintenance.

Always unplug the welder from its electrical outlet before performing any inspection, maintenance, or cleaning procedures.

4. Never leave the welder unattended while energised. Turn power off before leaving the welder unattended.

5. Do not touch live electrical parts. Wear dry, insulating gloves. Do not touch the electrode or the conductor tong with bare hands. Do not wear wet or damaged gloves.

6. Protect yourself from electric shock. Do not use the welder outdoors. Insulate yourself from the work piece and the ground. Use non-flammable, dry insulating material if possible, or use dry rubber mats, dry wood or plywood, or other dry insulating material large enough to cover the area of contact with the work or the ground.

7. Avoid inhaling dust. Some dust created by power sanding, sawing, grinding, drilling, cutting, welding and other construction activities, contain chemicals known to cause cancer, birth defects or other harm. Your risk from these exposures varies, depending on how often you do this type of work. To reduce your exposure to these chemicals, work in a well-ventilated area, and work with approved safety equipment, such as dust masks that are specially designed to filter out microscopic particles.

8. People with pacemakers should consult their physician(s) before using this machine.



WARNING!

Electromagnetic fields in close proximity to a heart pacemaker could cause interference, or failure of the pacemaker. The use of a Welder is NOT RECOMMENDED for pacemaker wearers. Consult your doctor.

9. Ensure that the unit is placed on a stable location before use.



WARNING!

If this unit falls while plugged in, severe injury, electric shock, or fire may result.

10. Transportation Methods Lift unit with the handles provided, or use a handcart or similar device of adequate capacity. If using a fork lift vehicle, secure the unit to a skid before transporting.



CAUTION!

Disconnect input power conductors from de-energized supply line before moving the welding power source.

11. Exercise good work practices. The warnings, precautions, and instructions discussed in this instruction manual cannot cover all possible conditions and situations that may occur. It must be understood by the operator that common sense and caution are factors which cannot be built into this product, but must be considered by the operator.



EZIMIG215C

Welding Safety Instructions & Warnings



WARNING!

Protect yourself and others from possible serious injury or death. Keep children away. Read the operating/Instruction manual before installing, operating or servicing this equipment. Have all installation, operation, maintenance, and repair work performed by qualified people.

If an operator does not strictly observe all safety rules and take precautionary actions, welding products and welding processes can cause serious injury or death, or damage to other equipment or property. Safe practices have developed from past experience in the use of welding and cutting.

These practices must be learned through study and training before using this equipment. Some of these practices apply to equipment connected to power lines; other practices apply to engine driven equipment. Anyone not having extensive training in welding and cutting practices should not attempt to weld.

Safe practices are outlined in the European Standard EN60974-1 entitled: Safety in welding and allied processes.



WARNING!

Only use safety equipment that has been approved by an appropriate standards agency. Unapproved safety equipment may not provide adequate protection. Eye and breathing protection must be AS/NZS compliant for the specific hazards in the work area.



DANGER!

Always wear AS/NZS compliant safety glasses and full face shield fitted with appropriate filter shade number (Refer Filter Table on page 17.)



CAUTION!

Heavy-duty work gloves, non-skid safety shoes and hearing protection used for appropriate conditions will reduce personal injuries.



CAUTION!

Have the equipment serviced by a qualified repair person using identical replacement parts. This will ensure that the safety of the power tool is maintained.

Personal Safety



CAUTION!

Keep the work area well lit. Make sure there is adequate space surrounding the work area. Always keep the work area free of obstructions, grease, oil,

trash, and other debris. Do not use equipment in areas near flammable chemicals, dust, and vapours. Do not use this product in a damp or wet location.

1. **Stay alert**, watch what you are doing and use common sense when operating equipment. Do not use a tool while you are tired or under the influence of drugs, alcohol or medication. A moment of distraction when operating equipment may result in serious personal injury.
2. **Do not over-reach**. Keep proper footing and balance at all times. This enables better control of the power tool in unexpected situations.

Arc Rays can Burn Eyes and Skin



DANGER!

Arc rays from the welding process produce intense heat and strong ultraviolet rays that can burn eyes and skin.

1. **Use a Welding Helmet or Welding Face Shield fitted with a proper shade filter** (refer AS 60974-1, AS/NZS 1337.1 and AS/NZS 1338.1 Safety Standards) to protect your face and eyes when welding or watching. (See Filter Table on Page 20)
2. Wear approved safety glasses. Side shields are recommended.
3. Use protective screens or barriers to protect others from flash and glare; warn others not to watch the arc.
4. Wear protective clothing made from durable, flame-resistant material (wool and leather) and foot safety protection.
5. Never wear contact lenses while welding.

Noise Can Damage Hearing



CAUTION!

Noise from some processes can damage hearing. Use AS/NZS compliant ear plugs or ear muffs if the noise level is high.

Work Environment Safety



DANGER!

Remove any combustible material from the work area.



EZIMIG215C

1. When possible, move the work to a location well away from combustible materials. If relocation is not possible, protect the combustibles with a cover made of fire resistant material.
 2. Remove or make safe all combustible materials for a radius of 10 metres around the work area. Use a fire resistant material to cover or block all doorways, windows, cracks, and other openings.
 3. Enclose the work area with portable fire resistant screens. Protect combustible walls, ceilings, floors, etc., from sparks and heat with fire resistant covers.
 4. If working on a metal wall, ceiling, etc., prevent ignition of combustibles on the other side by moving the combustibles to a safe location. If relocation of combustibles is not possible, designate someone to serve as a fire watch, equipped with a fire extinguisher, during the welding process and well after the welding is completed.
 5. Do not weld or cut on materials having a combustible coating or combustible internal structure, as in walls or ceilings, without an approved method for eliminating the hazard.
 6. After welding, make a thorough examination for evidence of fire. Be aware that visible smoke or flame may not be present for some time after the fire has started. Do not weld or cut in atmospheres containing dangerously reactive or flammable gases, vapours, liquids, and dust. Provide adequate ventilation in work areas to prevent accumulation of flammable gases, vapours, and dust.
 7. Do not apply heat to a container that has held an unknown substance or a combustible material whose contents, when heated, can produce flammable or explosive vapours. Clean and purge containers before applying heat. Vent closed containers, including castings, before preheating, welding, or cutting.
- wire welding, the wire, wire reel, drive roll housing, and all metal parts touching the welding wire are electrically live. Incorrectly installed or improperly grounded equipment is a hazard.
1. Do not touch live electrical parts.
 2. Wear dry, hole-free insulating gloves and body protection.
 3. Insulate yourself from the work and the ground using dry insulating mats or covers.
 4. Disconnect input power before installing or servicing this equipment. Lock input power, disconnect switch open, or remove line fuses so power cannot be turned on accidentally.
 5. Properly install and ground this equipment according to national, state, and local codes.
 6. Turn off all equipment when not in use. Disconnect power to equipment if it will be left unattended or out of service.
 7. Use fully insulated electrode holders. Never dip the holder in water to cool it or lay it down on the ground or the work surface. Do not touch holders connected to two welding machines at the same time or touch other people with the holder or electrode.
 8. Do not use worn, damaged, undersized, or poorly spliced cables.
 9. Do not wrap cables around your body.
 10. Connect work piece to a good electrical ground.
 11. Do not touch the electrode while in contact with the work (ground) circuit.
 12. Use only well-maintained equipment. Repair or replace damaged parts as soon as practical.
 13. In confined spaces or damp locations, do not use a welder with AC output unless equipped with a voltage reducer.

Electricity Can Kill



DANGER!

Touching live electrical parts can cause fatal shocks or severe burns. The electrode and work circuit is electrically live whenever the output is on.

The input power circuit and machine internal circuits are also live when power is on. In semi-automatic or automatic

Arc rays from the welding process produce intense heat and strong ultraviolet rays that can burn eyes and skin. Use the following table to select the appropriate shade number for a Welding Helmet or Welding Face Shield.



EZIMIG215C

Recommended Protective Filters for Electric Welding		
Description of Process	Approximate Range of Welding Current in Amps	Minimum Shade Number of Filter(s)
Manual Metal Arc Welding - Covered Electrodes (MMA)	Less than or equal to 100	8
	100 to 200	10
	200 to 300	11
	300 to 400	12
	Greater than 400	13
Gas Metal Arc Welding (GMAW) (MIG) other than Aluminium And Stainless Steel	Less than or equal to 150	10
	150 to 250	11
	250 to 300	12
	300 to 400	13
	Greater than 400	14
Gas Metal Arc Welding(GMAW) (MIG) Aluminium and Stainless Steel	Less than or equal to 250	12
	250 to 350	13
Gas Tungsten Arc Welding (GTAW) (TIG)	Less than or equal to 100	10
	100 to 200	11
	200 to 250	12
	250 to 350	13
	Greater than 350	14
Flux-Cored Arc Welding (FCAW) - with or without Shielding Gas	Less than or equal to 300	11
	300 to 400	12
	400 to 500	13
	Greater than 500	14
Air - Arc Gouging	Less than or equal to 400	12
Plasma - Arc Cutting	50 to 100	10
	100 to 400	12
	400 to 800	14
Plasma - Arc Spraying	—	15
Plasma - Arc Welding	Less than or equal to 20	8
	20 to 100	10
	100 to 400	12
	400 to 800	14
Submerged - Arc Welding	—	2 (5)
Resistance Welding	—	Safety Spectacles or Eye Shield

Refer to standard AS/NZS 1338.1 for comprehensive information regarding the above table.

Fumes And Gases



WARNING!

Welding produces fumes and gases. Breathing these fumes and gases can be hazardous to your health.

1. Keep your head out of the fumes. Do not breathe the fumes.
2. If inside, ventilate the area and/or use an exhaust at the arc to remove welding fumes and gases.
3. If ventilation is poor, use an approved air-supplied respirator.
4. Read the Safety Data Sheets (SDS) and the manufacturer's instruction for the metals, consumables, coatings, and cleaners.
5. Work in a confined space only if it is well ventilated, or while wearing an air-supplied respirator. Shielding gases used for welding can displace air causing injury or death. Be sure the breathing air is safe.
6. Do not weld in locations near degreasing, cleaning, or spraying operations. The heat and rays of the arc can react with vapours to form highly toxic and irritating gases.



EZIMIG215C

7. Do not weld on coated metals, such as galvanized, lead, or cadmium plated steel, unless the coating is removed from the weld area, the area is well ventilated, and if necessary, while wearing an air-supplied respirator. The coatings and any metals containing these elements can give off toxic fumes if welded.

Fire & Explosive Risks

- WARNING!** Sparks and spatter fly off from the welding arc. The flying sparks and hot metal, weld spatter, work piece, and hot equipment can cause fires and burns.

Accidental contact of electrode or welding wire to metal objects can cause sparks, overheating, or fire.

1. Protect yourself and others from flying sparks and hot metal.
2. Do not weld where flying sparks can strike flammable material.
3. Remove all flammables within 10m of the welding site.
4. Be alert that welding sparks and hot materials from welding can easily go through small cracks and openings to adjacent areas.
5. Watch for fire, and keep a fire extinguisher nearby.
6. Be aware that welding on a ceiling, floor, bulkhead, or partition can cause fire on the hidden side.
7. Do not weld on closed containers such as tanks or drums.
8. Connect the work lead/clamp to the job as close to the welding area as practical to prevent welding current from travelling long, possibly unknown paths and causing electric shock and fire hazards.
9. Do not use a welder to thaw frozen pipes.
10. Remove the stick electrode from the holder or cut off the welding wire at the contact tip when not in use.

Sparks & Hot Metal

- WARNING!** Chipping and grinding causes flying metal, and as welds cool they can throw off slag.

1. Wear an AS/NZS approved face shield or safety goggles. Side shields are recommended.
2. Wear appropriate safety equipment to protect the skin and body.

Cylinders

- WARNING!** Gas cylinders contain gas under high pressure. If damaged, a cylinder can explode. Since gas cylinders are normally part of the welding process, be sure to treat them carefully.

1. Protect compressed gas cylinders from excessive heat, mechanical shocks, and arcs.
2. Install and secure cylinders in an upright position by chaining them to a stationary support or equipment cylinder rack to prevent falling or tipping.
3. Keep cylinders away from any welding or other electrical circuits.
4. Never allow a welding electrode to touch any cylinder.
5. Use appropriate shielding gas, regulators, hoses, and fittings designed for the specific application; maintain them and their associated parts in good condition.
6. Turn your face away from the valve outlet when opening the cylinder valve.





EZIMIG215C

Warranty

As part of an on-going commitment to excellence in product support, Euroquip offers a comprehensive product warranty program.

Warranty period for the EZIMIG215C:

Commercial Use: 24 Months

Domestic Use: 24 Months

Warranty covers failure caused by manufacturing and material defects in the product, during the warranty period specified. The warranty period begins when the product is purchased by the end user. Warranty is not transferrable and is only claimable by the original purchaser.

Warranty does not cover parts that are subject to wear and tear from usage.

Warranty covers failure of a product caused by defective materials and/or manufacturing for the period given and the usage specified by Euroquip. The warranty period begins when the product is purchased by the end user. Warranty is not transferrable and is only claimable by the original purchaser.

Warranty also does not cover failure caused by the untimely replacement or service of the above wearing parts. Evidence must be provided that the product has been maintained and serviced suitably for a claim to be considered under warranty.

Failure caused by incorrect operation of the product, lack of proper care and maintenance of the product, external damage, external circumstances such as contaminated fuel or poor water supply, modifications to the product, attempted repair/ service by a party other than an Approved Service Agent, is not covered under warranty.

Warranty does not cover pre delivery service and adjustment, or failure that may occur as a result of lack of/ incorrect pre delivery service and adjustment.

Warranty does not cover any incidental, indirect or consequential loss, damage or expense that may result from any defect, failure or malfunction of a product.

Should any issue be found to be a combination of a warranty failure and a non-warranty issue, the repair cost component to rectify and repair the non-warranty failure is the customers' full responsibility.

The decision that an issue with a product qualifies as a warranty claim is made at the sole jurisdiction of Euroquip.

No costs incurred will be considered under warranty if repairs are carried out by a party other than a Euroquip Approved Service Agent, unless with prior consent in writing from Euroquip.

It is the responsibility of the purchaser to deliver a product under warranty to the nearest relevant service agent or product reseller. Warranty does not cover call outs, mileage and freight costs.

If a product is repaired under warranty, parts and labour required for the repair will be supplied at no charge. Warranty assessment and repair will be scheduled and executed according to the normal work flow at the service location and depending on the availability of suitable replacement parts.

This warranty policy is an additional benefit and does not affect the legal rights of any end user, reseller or service agent.



EZIMIG215C



Congratulations on your new STRATA product. We are proud to have you as our customer and will strive to provide you with the best service and reliability in the industry. This product is backed by our extensive warranty. To locate your nearest distributor or service agency visit www.strata.co.nz, or email us at CustomerService@euroquip.co.nz

www.strata.co.nz